

December

Price 15¢

# QST

A MAGAZINE DEVOTED EXCLUSIVELY TO THE WIRELESS AMATEUR

MERRY XMAS

1919



Everybody in the A.R.R.C.  
wishes every other amateur  
A very Merry Christmas  
and A Happy New Year.

H.P. WICK

# ATLANTIC RADIO COMPANY

34 BATTERY MARCH ST.

BOSTON, MASS.

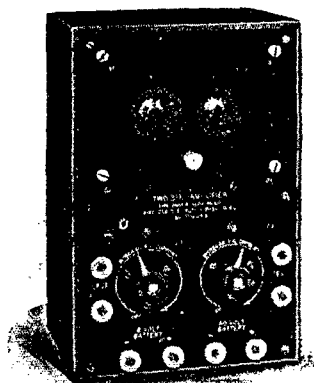

WRITE FOR  
BULLETIN

10

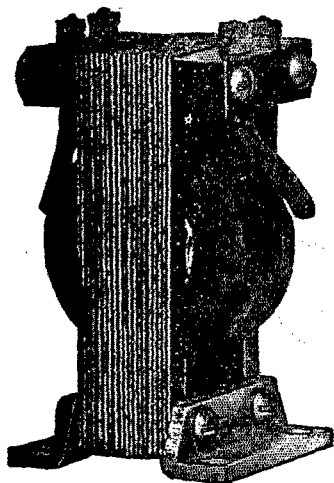

**Triode "B" Two-Stage Amplifier,**  
oak cabinet, Bakelite panel. A  
beautiful and efficient piece of  
apparatus.

Price \$69.00

**Amplifying Transformer.**  
The same transformer used  
in complete amplifying units.  
Ratio 1-3.

Price \$7.00 each

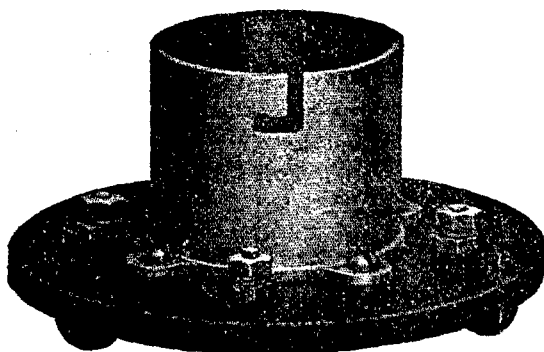

**The leader among tube sockets.**  
Aluminum socket, Bakelite base.  
Easy access to building posts for  
connections.

Note the low price—\$1.25

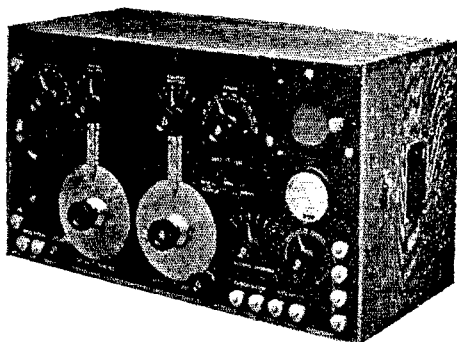

**A complete receiving set.**  
No. I-P-501. Range 250—8000  
meters. Hundreds used by the  
U. S. Navy.

Price \$348.00

## QUALITY APPARATUS

# QST

VOLUME III

DECEMBER, 1919

NO. 5

## CONTENTS

3. A Short Wave Regenerative Receiver D. F. Alexander
5. Transmitter Resonance R. H. G. Mathews
6. "S. O. L." Irving Vermilya
8. Wave Meter Construction and Operation L. Gerard Pacent
10. QST's Directory of Calls
14. Calls Heard
14. Erratum
15. Editorials
17. On Handling Traffic Edw. A. Gisburne
18. An Experimental Busboard
19. QST Subscription Contest
23. Who's Who in Amateur Wireless
24. "Strays"
26. Radio Communications by the Amateurs
31. The Operating Department
38. The Junior Operator
43. Amateur Radio Stations
45. Queries Department
46. A.R.R.L. Roll of Honor
47. An Audion Oscillator and Tone Circuit M. B. Sleeper
48. How to Make a Simple Variometer John M. Clayton

QST is published monthly by The American Radio Relay League, Inc., at Hartford, Conn. Kenneth B. Warner (Secretary, A. R. R. L.), Manager and Editor.

Subscription price, \$1.50 per year in the United States and possessions; Canada, \$1.75; Foreign, \$2.00. Single Copies, 15 Cents.

Entered as second-class matter May 29, 1919, at the post office at Hartford, Connecticut, under the Act of March 3, 1879.

Copyright, 1919, by The American Radio Relay League, Inc.  
Title registered at United States Patent Office.

THE AMERICAN RADIO RELAY LEAGUE, Inc.  
HARTFORD, CONN.

# TWO-STEP AMPLIFIER

TYPE TRIODE E

**PRICE**  
(without tubes)  
**\$39.00 Postpaid**

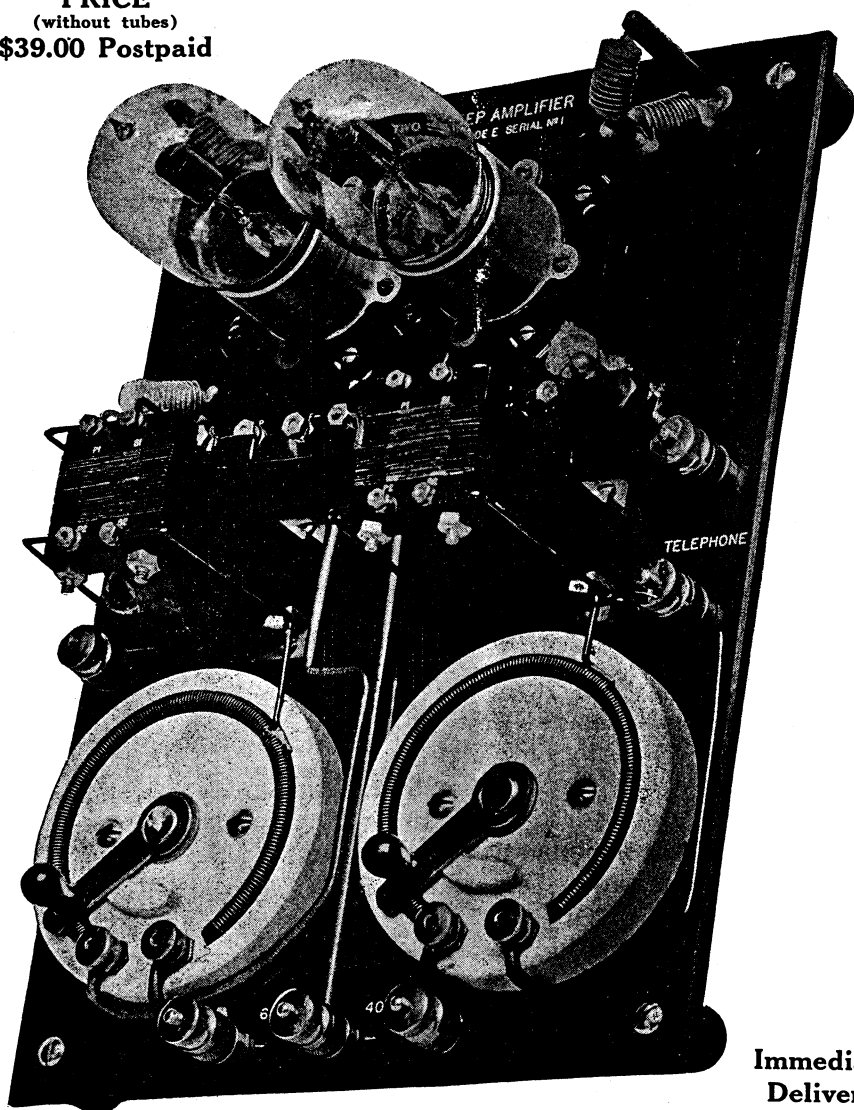

**Immediate  
Delivery**

Due to its operation on the principle of voltage amplification thru resonance this amplifier provides a maximum of low frequency amplification and is superior to all others.

- Permits reliable daylight reception from European stations.
- Establishes new amateur long distance records.
- Renders remarkable amplification of all signals.
- May be used with Marconi and all standard tubes.

**WIRELESS SPECIALTY APPARATUS CO.**  
**BOSTON, MASS., U. S. A.**

# QST

A Magazine Devoted Exclusively  
to the Radio Amateur

## A Short Wave Regenerative Receiver

By Donald F. Alexander

The capacitative-regenerative set described in QST for December, 1916, was constructed by countless QST readers, whose many letters have attested the splendid results accomplished with it. This article is a description of a tickler-feedback set, and is destined, we believe, to be as popular. In common with the tuned-plate-circuit regenerative sets, these sets are admirably suited to our relay work, but the former, when containing variometers, are difficult of construction in the home workshop. Mr. Alexander's set is a cinch.—Editor.

**M**OST amateurs, after listening to long wave arcs for a time, begin to wish they had a good efficient short wave set that would enable them to get LD amateurs and still be able to receive ships, as well as special amateurs. Others, who have never owned a LW undamped receiver but who are eager for LD amateur work, are looking for a short wave regenerative receiver of simple construction, compact, efficient, and of low cost. The following described receiver was designed with just such a view in mind. With it, stations from Cuba to Labrador have been heard in Bangor, Maine, on a small antenna. The wave length range is 150 to 700 meters.

The cabinet may be of any size, but one of just the right dimensions is 9 inches long, 5½ inches high, and 4½ inches deep, inside measurements. The wood may be of any kind, but if the panel is of wood it may be white pine. Dark mahogany, well rubbed, makes a good finish.

The panel, which is 10½" x 5½" x ¼", is drilled as in Fig. 3. Any switch knob and lever can be used. The panel should be drilled for 11 switch points for each switch lever. Eight binding posts are required, two for aerial and ground, two for phones, two for the "A" battery, and two for the variable condenser. These last two are placed on the top of the cabinet, and the other six may be arranged as in Fig. 1.

The sizes of the coils are as follows:

Primary: 2.75" diameter by 2.5" long, wound 1.75" with 75 turns of No. 22 D.S.C.

wire. Tapped at the 10th, 20th, 30th, 40th, 45th, 50th, 55th, 60th, 65th, 70th, and 75th turn.

Secondary: 2.5" diameter by 1.5" long, wound 1.1" with 42 turns of No. 26 D.S.C. wire; no taps.

Secondary Load: 2.75" diameter by 4" long, wound 3" with 150 turns No. 26 D.S.C. wire tapped every 15th turn (126 inches of wire to each tap).

Tickler: 2.4" diameter by 1.5" long, wound 1.1" with 42 turns of No. 26 D.S.C. wire (314" of wire).

The tubes used were two mailing tubes. Tubes of the sizes needed can easily be found at music stores.

The primary is placed as in Fig. 2 and fastened thru the bottom by a 8-32 battery bolt. The secondary coupling is varied by the means shown in this figure, or by any alternative method desired. In the system shown, the small roller winds up the string, which goes thru a pulley fastened to the left side of the cabinet. A long brass-headed carpet tack makes a good means of fastening the far end of the dowel.

The secondary loader, with tickler placed inside, is located upright in the right side of the box. This arrangement minimizes the inductive effect from the coupler. It is fastened thru the right-hand end of the cabinet with a 8-32 battery bolt.

The primary taps are brought to the left-hand switch and those from the secondary load to the right-hand switch. The back of the cabinet may be left off until the connections are made.

In the set made by the writer a Marconi bulb was used, and a socket for the standard four-prong tube is mounted close to the panel on the left. There is just room behind this and on top of the primary to place a 22.5 volt block "B" battery,  $3\frac{1}{2} \times 2\frac{1}{2} \times 2$ . A rheostat is mounted on the right-hand end, outside. A small fixed grid condenser can be made (two  $4 \times 4$ " tin-foils) and screwed to the rear of the cabinet by means of a narrow wood strip.

The wires to the two binding posts on the top are flexible and about a foot long. If it is desired to put the variable condenser on a level with the cabinet, the binding posts may be placed on the panel. The sizes and arrangement can be changed as most convenient to the constructor, but the writer considers the data given to be most satisfactory.

In operation, the bulb is lighted to ordinary brilliancy (just below the hissing point) and the variable, of .0005 mfd. preferably, is turned from 180 degrees toward zero. If no click is heard in the phones, readjust the "A" battery. If still the oscillating condition is not obtained, reverse the tickler connections. The set is oscillating when the movement of the secondary load switch causes a click in the

phones. When properly oscillating, turn the condenser to 180 degrees and tune in the desired station. Then turn the variable down until just above the non-oscillating point. If the coupling between primary and secondary is sufficiently loose, the signals should come in very much amplified. If it is desired to receive the true note, turn the variable down to just below the oscillating point. A little practice will quickly show the most desirable adjustment.

(Editor's Note. The objection to short-wave regenerative sets with tickler feedback heretofore has been the highly critical tickler coupling adjustment necessary. Mr. Alexander has ingeniously solved this by using a maximum coupling between tickler and grid circuit and then employing the variable by-passing condenser across the phones simply as a throttle; i.e., at low values it does not pass enough energy to sustain oscillations, and the value for proper feedback for regenerative amplifications of damped signals is easily found. This is much more satisfactory than a variable tickler coupling, but if the constructor desires, the tickler may be made to rotate without any change in design, using a control knob on the right-hand end of the cabinet.

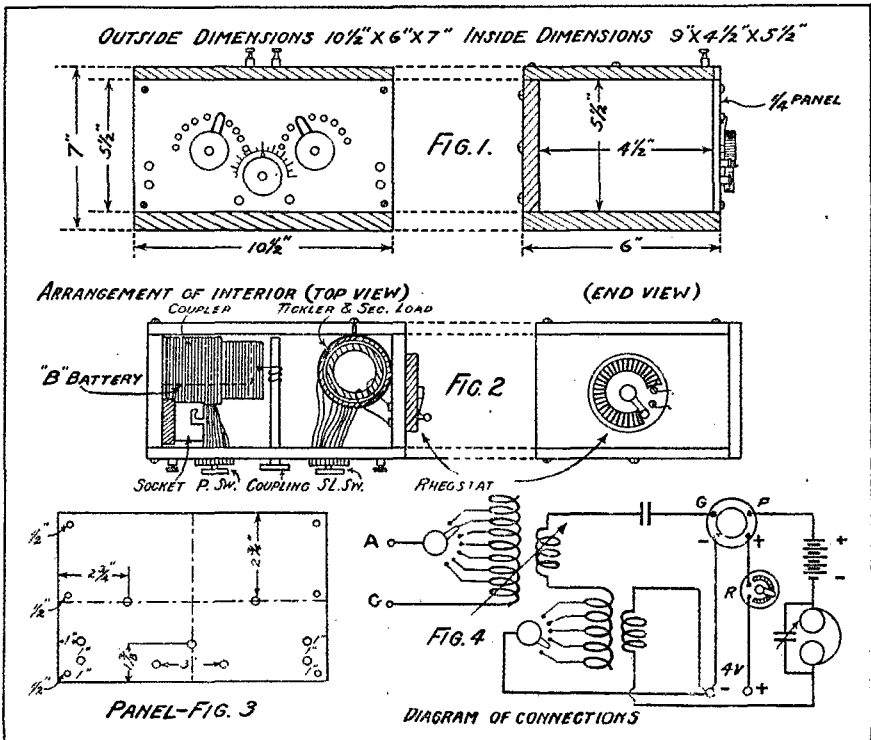

# Transmitter Resonance

By R. H. G. Mathews

—A concise and timely explanation of a very important but commonly disregarded feature of amateur transmission.—

IT has been apparent to the writer for some time that many amateurs in tuning and adjusting their transmitters do not give sufficient attention to the resonance between the primary oscillating circuit, consisting of the gap, condenser and primary of the oscillation transformer, and the primary power circuit.

In order to simplify and shorten this article, no attempt will be made herein to show mathematically the effect of the relation between the transmitting capacity and inductance and the lead and lag of current and voltage in the primary power circuit. The fact that there is such a relation is too well known to require further comment. It will be assumed, therefore, that there is a certain relation between these factors which will result in maximum transmitter efficiency, and the two methods of finding this certain relation will be discussed.

In tuning the primary of a transmitter to a given wave length, many inductance values will be found with corresponding capacities which will give the desired wave length. Only one of these combinations however, is the best, as stated before.

The first method of determining this particular combination is by the use of a hot wire or other high frequency ammeter in the primary oscillating circuit. The oscillation transformer secondary should be removed from inductive relation to the primary, and the high frequency ammeter shunted across a turn or fraction of a turn of the primary inductance, the exact amount of inductance to be so shunted being determined by test, it being desirable to use nearly full scale on the meter, the current varying directly with the inductance value shunted. In this connection, attention is called to the fact that the leads to the ammeter should be as short and of as heavy material as possible to reduce error to a minimum.

After connecting the meter in as above, the transmitter primary (oscillating circuit) should be tuned to the desired wave length, using varying combinations of inductance and capacity until that combination is found which gives the greatest reading on the ammeter, it being, of course shunted across the same amount of inductance throughout the test. The oscillation transformer secondary should then be added and connected up and the set tuned to resonance in the usual manner.

If the gap frequency is variable it may be adjusted for each inductance-capacity combination at the same time the other adjustments are made. The usual methods of measuring decrement are, of course, employed after adding the antenna inductance. When the method as outlined above is used in resonating, the power input should not be varied in any particular.

The second method of securing resonance is by the use of a primary choke coil having an adjustable core. In making up such a coil, care should be taken to use sufficiently heavy wire that the factor of resistance is very low, the impedance predominating. In this method, the primary oscillation circuit is tuned to the wave desired, using inductance and capacity values as desired, it being considered that it is always desirable on short wavelengths to use as much capacity as possible, in order to utilize fully the 1 kilowatt power input allowed by law. The inductance should not, however, be cut down to less than one turn, in favor of increased capacity.

After tuning the primary, the secondary or antenna circuit should be resonated in the usual manner.

The variable core choke coil should now be connected in series with the transformer primary and a wattmeter, voltmeter and ammeter connected in the circuit. A power factor meter may be substituted for the voltmeter and ammeter if available. Adjustment should now be made of the choke coil core, until the power factor is at its greatest value as shown by the formula

$$f = \frac{W}{EI}$$

where W = input in watts, E = voltage, I = current and f = power factor.

It will be found that with a reduction in actual wattage input will often come a proportional increase in antenna current or radiation, due to the increased efficiency produced by perfect resonance throughout the set.

An adjustment to resonance along one of the foregoing plans, in addition to the usual methods of tuning a transmitter, is strongly advised by the writer, and it is believed that a tremendous increase in transmitting efficiency and consequent improved long distance transmission will result.

## "S. O. L."

By Irving Vermilya

Mr. Vermilya will be remembered by QST readers as the author of "Amateur Number One", a laughable tale of the days of the real old timers in the amateur game. He is now Assistant Shift Engineer at the Marconi Station at Marion, Mass., and meditates upon his happy days in the Navy during the recent unpleasantness. His tale will strike many a responsive chord among our readers.

I'M notta going to have to tell any wire-less bug that was in the navy what S. O. L. stands for, and before you finish this you'll understand it's got a powerful lot to do with being outta luck. Nuff said. That's me—I sure was outta luck nine-tenths of the time. No, I'm not looking for any sympathy; all I ask is—pursue this tale, all ye radio bugs, and see if you can see any experiences that will resemble any of yours. I haven't interviewed all the amateurs I ever knew about "How'd you like the Navy" but it's a safe guess that the next war, when it comes and if we're alive, Josephus Dangle-nails will find the Gang in the Army wearing officer's uniforms.

What a lovely day was last April 7, 1917, when I sauntered off down to Provincetown—that dear, quaint little fishing town on the tip of Cape Cod—and asked Ensign Oh Pshaw "What's the chances of gettin' in this here Naval Reserve force you fellows is going to start up?" "Yes, yes", came the happy response; "surest thing you know; I've been waiting for you for three days now." "How nice", thot I. "Here's where I get to be a regular fellow—I'll be the first one on Cape Cod to volunteer, and dear old Marconi will pat me on the back." So Old Boy Pshaw did there and then enroll Marconi's Manager as a Chief Petty Officer. I might have been a deck swabber or a Rear Admiral, for all I knew about it, but I was carried away with enthusiasm and patriotism, and I even forgot to ask him whether a CPO got paid in the Navy or not. They don't! You get a little cash once in a while, but it ain't what you'd call a regular payday, because it don't come that way, and besides when it did come it had already been spent. Talk about yellow slips—well, I got enough of them to paper a house with. I took sick the day they stopped coming after a period of 'em spread out over four months, and the doctor says I'll never be the same.

But let's go back. War was declared; Pshaw called up and said "You are Commanding Officer at South Wellfleet; you are Chief Electrician, Radio. The Marines are coming." "Ah, fine!", thot I, "here's where I learn something and gather worlds of experience." The next day was Sunday,

and sure enough down came six marines and a corporal, each one with a great big rifle slung over his shoulder and all ready for business. What an impressive sight as they marched up the pathway, thot I. "This surely will be a great place; I've been here all alone for three years. Now for some company". So I strapped my big 45 Colt and belt full of bullets around me and went out to meet and greet them. And lo and behold! No more had the corporal arrived than he informed me he had to come along without any bullets. Some army; talk about Carranza's outfit. My Gawd, I nearly passed away. I still laugh when I think of it, and I nearly spoiled my dinner yesterday when I made a call at the cable station in Orleans and found a marine still on guard and the war's been over some months. No, I'm not an anarchist or a red flag man, but honest, Anabelle, some things are funny to me. I know of one high power radio station where neither marines or any other guard ever did arrive. There are fourteen poles, thirty miles of aerial wire, and a million dollars worth of property there, and it could have been blown to seven bells and a jingle if anyone wanted to do it. The skipper didn't care—that's why he didn't have the guard. Besides, he told me, he didn't like the leathernecks. So he should worry; the station didn't work anyway; and they went to sleep at night, trusting to Hannah no one would be so mean as to blow 'em up.

Well, the Bulletless Marines landed. Next thing we did was to march—on to David I. Buitekan's little shop, combination post office—gasolene wagon's retreat—ice cream, popcorn, cake and candy. Everyone grabbed an arm full of groceries and the general retreat for quarters was once more begun.

Chaffee—a buck private Marine of Swedish direct (not descent)—was elected cook. If I live to be a thousand I shall never forget Chaffee as a cook. Grease—Oh Boy! However, we managed. I never knew a bunch of Marines that didn't. You could set a Marine down at the North Pole and he'd find a stove to keep him warm.

Next day brought "sad news from home", for behold! none other arrives upon the scene but his Honor J. W. Teapot Mull-



doons, First Class Electrician, Radio, U. S. N. His boss also arrived, in the person of Gunner Jane, the only original guy at whom all radio men, politicians, and superior as well as inferior officers should tremble whenever he looked at 'em real hard-boiled-like. Mulldoons was placed in charge and my career as a K. O. died abruptly. I very suddenly discovered that in their estimation everything that Marconi had ever done, hoped to do, or ever would do was rotten—rotten beyond repair and all hopes. Not only did this apply to equipment all over the world but every Marconi operator and his uncle were the same way. In fact we weren't operators at all; everybody—in Marconi, in the Reserve, all the amateurs—were hams, downright hams. The operators, thank you, were all in the Regular Navy. "How nice", thot I, "I'm going to have a regular little teaparty around here." But it wasn't so bad. Things started out pretty good, and in the excitement I lost track of these bright remarks. We signed a death warrant for the dear old station and the following Wednesday it was no more as far as Marconi was concerned.

Next day there was more excitement. Imagine my surprise when a gob with a wooden leg reported for duty! Sure enough, tho—one of the other gobs swore he saw it lying on the floor one night when he called him for relief. He was over six feet tall and built on the order of a ram-rod. When he had a flat hat on you'd swear it was a piston rod you saw. But hats off to him—he was a very decent fellow and with a good disposition. He soon acquired the nickname of B.V.D. which speaks for itself that he was a good feller.

Next in line to arrive was the cutest little gob, Arthur Steeves. The only thing I can recall that was interesting was that he had an everlasting habit of cleaning his teeth, and he knocked a side off the Selectman's house in Wellfleet one day with a twin-cylinder Indian. He escaped alive.

Enter next upon the stage Mr. Albert Smith, Chief Cook and Bottle Washer. Gob, cook—oh, excuse me, let's get sea-going—Ship's Cook 2nd class. We now come down to the fact that "Smidy's" arrival meant the end of leatherneck Chaffee's career as a cook. No tears were shed. Poor Smidy—he had only one regret as long as he bunked at South Wellfleet, and that was that during the wild poker games that eventually came to pass there he had a queer habit of betting all the chips before him on a pair of Jacks. How I smile when I recall Smidy saying "Well, I guess I'll take the whole woiks out for an airing", as he shoved every chip to the middle of the table. On several

occasions this proved so disastrous to poor Smidy that he didn't hire any taxi-cabs the rest of the month and spent a lot of time in very simple pastimes—very simple indeed.

We thot we had the last word in the cook line till one bright and sunny day appeared over the horizon one William Josephs, the wildest man in captivity. I ran afoul of said Bill along the State Highway, steering a Tin Lizzie head on to me. Bill was a great looking sight—he had been troubled with boils and hadn't shaved for three weeks. Well, he wanted a job in the Navy, poor cuss, so I sent him to his Royal Highness Ensign Oh Psnaw to see what was doing. By this time Pshaw had a feeling he was in Admiral Sim's class, and when Bill had piloted that poor Lizzie seventeen miles to Provincetown to enlist, Poo Poo Pshaw very regulation-like informed him that anyone that came to him from Chief Vermilya was null and void and that he'd have to go back over those seventeen miles and see J. W. Teapot Mulldoons and then return to him. Thanks to Bill's everlasting courage he covered thirty-four more miles back and forth and finally enlisted—first class ship's cook. Joe, as he was frequently called, was some cook, what I mean. He was there—the best over, and the boys all liked him. I saw some cooks during my brief stay, but Joe had it on 'em all.

'Twas only a few more days before in blew another detachment. One among them, a recruit from Harvard, was brand new and one of the first attempts. We will call him Moo Hoo for short, and especially is the name fitting 'cause it's like a Chinaman's name and he came the nearest to looking like a native of Peking. One old fisherman on the Cape handed him his laundry one day, so it wasn't all imagination. Moo Hoo finally pulled some string and was transferred to Boston, lucky boy.

It wasn't many weeks more before Mr. J. W. Teapot Mulldoons was called to the front and togged out all nice and sweet in a C.P.O. uniform. Oh yes, brand new. The only reason why he didn't look like a big Irish cop was because he wasn't big. It was almost fatal to me the day he sprung it that he was French. If he was French so was O'Sullivan. But said J. W. Teapot was now a Chief Petty Officer, commander at that pile of junk known as Marconi's Radio Station. At first I was delegated to be "nice and accomodating" and show the boys all the circuits and switches and how they worked. I was not to be bothered and made so common as to have to stand watches or anything like that. Just see that everything "went all right". Well, it did—and so did I. I went

(Concluded on page 25)

# Wave Meter Construction and Operation\*

By Louis Gerard Pacent †

IN TWO PARTS: PART I.

A wave meter is essentially a calibrated closed oscillatory circuit having inductance and capacity, either or both of which are variable, and having some current indicating device. The resistance of such a circuit is made as small as possible in comparison with its inductance. A characteristic of such a circuit is that it responds most strongly to an electromotive force which is of the same frequency as the natural frequency of the circuit, that is, the frequency at which the circuit will oscillate by itself. If such a circuit is coupled with an oscillatory circuit whose frequency it is required to obtain it will be found that for a certain value of capacity and inductance in the wave meter circuit a maximum value of current is indicated in that circuit. This indicates that the frequency of the oscillations in the primary circuit is the same as the natural frequency of the wave meter circuit. The natural frequency of the wave meter circuit at these particular values of inductance and capacity has been determined by calibrating the wave meter circuit against a circuit of known frequency. The wave meter circuit is commonly provided with a scale for directly reading therefrom the frequency for any given value of its variable inductance and variable capacity. The wavelength may also be read from a proportionate scale which is determined from the following relation.

The relation between the wave length ( $\lambda$ ), the velocity of propagation of the wave ( $V$ ), and the period ( $T$ ) of the oscillatory system is given by the equation

$$V = \frac{\lambda}{T} \quad \text{or} \quad T = \frac{\lambda}{V}$$

and since  $n = \frac{1}{T}$

$$V = n\lambda \quad \text{or} \quad \lambda = \frac{V}{n}$$

That is, the wave length in meters is equal to the velocity of the wave in meters per second divided by the frequency in cycles per second.  $V$ , the velocity of the wave, is equal to 300,000,000 meters per second. The expression for wave length may be reduced to a very convenient practical form as follows:

\*Courtesy Radio Club of America  
†Manager, Wireless Dept., Manhattan Electrical Supply Co., Inc.

Wave length in meters =  $1885 \sqrt{CL}$   
where  $C$  is expressed in microfarads and  $L$  in microhenries. This equation may be used for the purpose of calculating the value of inductances and capacities as will be described later.

There are several methods of determining when maximum energy is present in the wave meter circuit; some of the most suitable for amateur use are here briefly described. A small flash light lamp may be connected directly in series in the wave meter circuit as in Figure 1. The lamp glows brightest when the maximum current flows in the wavemeter circuit. This arrangement requires that considerable energy be present in the circuit so that the lamp may glow, and it is therefore applicable only to the measurement of the wave length of a transmitter.

Another method limited to measurements on transmitters is that shown in Figure 2. Here a neon or helium tube may be connected across the terminals of the condenser. The tube will glow most brilliantly when the maximum potential is impressed across it, which condition obtains at resonance.

A most convenient device for detecting small currents is a rectifying crystal detector and telephones connected in shunt with the condenser of the wave meter as shown in Figure 3. Maximum sound will be heard in the telephones when the wave meter circuit is in resonance with the circuit being measured.

Figure 4 shows a hot wire milliammeter (MA) connected directly in series with the inductance and capacity of the wave meter. This milliammeter may have a range of 0 to 100 milliamperes, and not only will permit the determination of the resonance point but by its use resonance curves may be plotted, as this meter indicates the actual values of current flowing in the wave meter circuit as the circuits approach or depart from resonance. Where the resistance of the milliammeter is high it is impossible to connect it directly in series. The connection should be either that of Figure 5(a) in which the meter is associated inductively with the wave meter circuit, or that of Figure 5(b) in which the meter is associated conductively with the wave meter circuit.

Figure 6 shows the detector and head telephones connected to the wave meter unilaterally. This arrangement is advantageous in that the capacity of the tele-

phones and detector is not shunted around the condenser proper of the wave meter thereby changing the calibration. This change usually is quite small but may become serious if the capacity of the condenser is very small.

The wave meter may also be used as a miniature transmitter to excite nearby oscillatory circuits. The scheme of connections is shown in Figure 7 (a). Here a high pitch buzzer has its circuit completed through the inductance of the wave meter. The buzzer is operated by one or two dry cells, a switch or key being used to close the circuit. While this arrangement is quite satisfactory when using small inductance coils, it is necessary to com-

ably uniform. In twelve that were measured the capacity did not vary by more than 0.0002 microfarads on either side of an average maximum capacity of 0.00097 microfarads.

Four inductance coils were found necessary to cover the desired range of wave length. All were wound on ordinary cardboard tubing 5 inches (12.7 centimeters) in diameter. Coil No. 1, having a range from 150 to 500 meters was wound on a tube two inches long. It consisted of 19 turns of No. 20 S. S. C. magnet wire. The length of the winding was  $\frac{3}{4}$  inch (1.9 centimeter). Its inductance was 78.65 microhenries. The wave lengths corresponding to the various settings of the

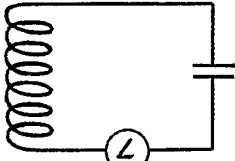

FIG. 1.

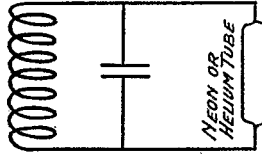

FIG. 2.

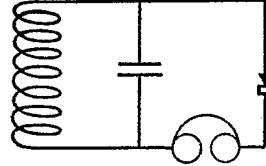

FIG. 3.

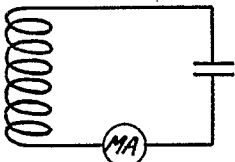

FIG. 4.

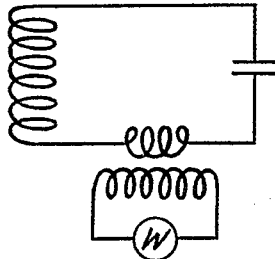

FIG. 5A.

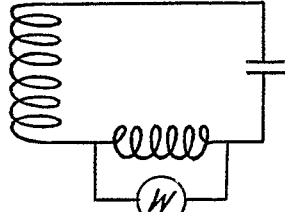

FIG. 5B.

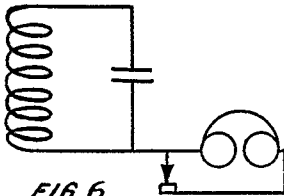

FIG. 6.

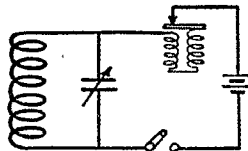

FIG. 7A

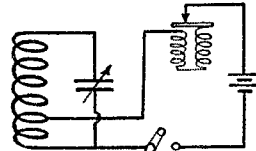

FIG. 7B

plete the buzzer circuit through but a portion of large coils [as in Figure 7 (b)], when in use, due to their high resistance.

The writer has constructed a wavemeter with a range from 150 to 15,000 meters, endeavoring to use standard material so that the inductances can be made from the dimensions herein given. The capacity used was the stock Murdock 43 plate variable condenser having an approximate maximum capacity of 0.001 microfarads. The curve of Figure 8 gives the capacity in microfarads of the above condenser for the corresponding condenser scale degrees. These condensers were found to be remark-

ably uniform. In twelve that were measured the capacity did not vary by more than 0.0002 microfarads on either side of an average maximum capacity of 0.00097 microfarads.

Four inductance coils were found necessary to cover the desired range of wave length. All were wound on ordinary cardboard tubing 5 inches (12.7 centimeters) in diameter. Coil No. 1, having a range from 150 to 500 meters was wound on a tube two inches long. It consisted of 19 turns of No. 20 S. S. C. magnet wire. The length of the winding was  $\frac{3}{4}$  inch (1.9 centimeter). Its inductance was 78.65 microhenries. The wave lengths corresponding to the various settings of the condenser are tabulated in Table I from which the curve of Figure 9 was drawn.

Coil No. 2, having a range from 400 to 1500 meters was wound on a tube four inches long. It consisted of 78 turns of No. 20 S. S. C. magnet wire. The length of the winding was  $3\frac{3}{8}$  inches (7.8 centimeters). Its inductance was 716.00 microhenries. The wave lengths corresponding to the various settings of the condenser are tabulated in Table II from which the curve of Figure 10 was drawn.

Coil No. 3, having a range from 1200 to 4200 meters was wound on a tube nine inches long. It consisted of 280 turns of

No. 26 S. S. C. magnet wire. The length of the winding was 7 1/2 inches (19.0 centimeters). Its inductance was 52,000 microhenries. The wave lengths corresponding to the various settings of the condenser are tabulated in Table III from which the curve of Figure 11 was drawn.

Coil No. 4, having a range from 4,200 to 15,000 meters, was wound on a tube twenty-five inches long. It consisted of 1650 turns of No. 28 S. S. C. magnet wire. The length of the winding was 24 inches (60.8 centimeters). Its inductance was 61,900 microhenries. Its D.C. resistance was 134 ohms. This is disadvantageous but allowable in this case as larger wire or litz-

draht occupies too much space and is much more costly. The wave lengths corresponding to the various settings of the condenser are tabulated in Table IV from which the curve of Figure 12 was drawn.

If possible it is advisable to calibrate a wave meter constructed as above against a standard. However if such a standard in not available it is possible to secure according to these directions a wave meter accurate within 5%.

(To be continued.)

**Editor's Note:** The condenser and wave-meter curves will appear in the second installment of this article.

Table I		Table II		Table III		Table IV	
Condenser scale degrees	Wave length	Condenser scale degrees	Wave length	Condenser scale degrees	Wave length	Condenser scale degrees	Wave length
15	158	10	404	10	1110	14	4150
20	180	20	545	20	1450	25	5350
30	216	40	750	40	2005	40	6722
40	247	60	924	60	2430	60	8400
60	300	80	1045	80	2820	80	9825
80	348	90	1105	120	3490	100	10870
100	388	100	1155	140	3758	120	12000
120	424	120	1295	160	4000	140	12970
140	455	140	1358	180	4225	160	13810
160	485	160	1440			170	14420
170	502	170	1492			180	14620

## QST's Directory of Calls

**E**ACH issue until the appearance of the Department of Commerce's List of Radio Stations containing amateur calls, QST will publish all reported call-letters--one of the most important duties we can perform in these days. Help us to make it complete by telling us your call as soon as it is assigned you. Calls will be listed alphabetically by districts, and will appear but once. See preceding issues of QST for calls already reported.

### FIRST DISTRICT

Mass. Inst. of Technology	Cambridge, Mass.	1AN
Leon C. Tanney	49 Fairmount St., Boston	1AR
Ernest Wood	2 Baldwin Terrace, Everett, Mass.	1BF
James B. Butler	30 Burlington St., Woburn, Mass.	1BI
Louis F. Eaton	210 Ash St., Brockton, Mass.	1BS
Harry B. McLane	342 Union Ave., Laconia, N. H.	1CM
Benjamin L. Ellis	148 Bradford St., Everett, Mass.	1CN
Frank Wigglesworth	2 West Hill Place, Boston, Mass.	1DA
Everett Gordon	34 Batterymarch St., Boston, Mass.	1DB
J. G. Campbell	128 Howard Ave., Roxbury, Mass.	1DC
Ralph S. Johnson	20 Cambridge Terrace, Cambridge, Mass.	1DD
William L. Collins	44 Carver Road, Newton Highlands, Mass.	1DE
A. H. Wood, Jr.	17 Cabot St., Winchester, Mass.	1DF
George W. Butterfield	14 Birch Hill Ave., Wakefield, Mass.	1DG
Allerton W. Whittier	63 Terrace Ave., Winthrop, Mass.	1DH
Edward A. Gisburne	12 Oakley St., Roxbury, Mass.	1DI
Arthur E. Ridley	49 Beacon St., Winthrop, Mass.	1DJ
Kendall A. Redfield	18 Mace Place, Lynn, Mass.	1DK
William L. Lewis, Jr.	226 Upland Road, Cambridge, Mass.	1DL
Conover Fitch	50 Dunster Road, Brookline, Mass.	1DM
Harry E. Duncan	34 Foster St., Newtonville, Mass.	1DN

Olof Ohlson	472 Crafts St., Newton, Mass.	1DO
Edward E. Hayward	32 Mellen St., Cambridge, Mass.	1DP
Stuart M. Briggs	94 Walnut Place, Brookline, Mass.	1DQ
Lester A. Pulley	33 Porter St., Melrose, Mass.	1DR
Edgar W. Nickerson	16 Atlantic Ave., Beverly, Mass.	1DS
Barton G. Albert	567 Hanover St., Fall River, Mass.	1DT
Conrad T. Beardsley	69 High St., Portland, Maine	1DU
Francis H. Cummings	6 Joy St., Boston, Mass.	1DV
Stanley F. Ware	75 Winthrop St., Everett, Mass.	1DW
Roger W. Semons	2 Waverly Ave., Cliftondale, Mass.	1DX
A. V. Johnson	110 Henry Ave., Lynn, Mass.	1DY
J. F. Archibald	19 South St., Medford, Mass.	1DZ
C. G. Mackintosh	93 Judson St., Malden, Mass.	1EA
G. A. Marsh	34 Cambridge Terrace, Cambridge, Mass.	1EB
H. E. Foley	32 Tufts Ave., Everett, Mass.	1EC
Ralph H. Hersey	43 Bay View Ave., Salem, Mass.	1ED
Arthur M. Greim	11 Parkton Road, Boston, Mass.	1EE
Stillman E. Chubbuck	71 Kimball Lane, Framingham, Mass.	1EF
Cleon C. Hammond	High St., Abington, Mass.	1EG
R. D. Brewer	26 Broadway, Newtonville, Mass.	1EH
W. C. Erwin	529 Shirley St., Winthrop, Mass.	1EI
Edward J. Wurtz	141 Centre St., Roxbury, Mass.	1EJ
Robert D. Houston	19 Novena St., Portland, Maine	1EK
Roger E. Bates	148 Pine St., Wollaston, Mass.	1EL
Edward L. Bellknap	91 Vine St., Hartford, Conn.	1EN
F. K. Ostrander, Jr.	254 Franklin St., Springfield, Mass.	1EO
Harry J. Hoffman	8 Estrella St., Jamaica Plain, Mass.	1EP
Thomas E. Kissling	76 Prospect St., Somerville, Mass.	1EQ
A. C. Specht	2 Kimball Road, Watertown, Mass.	1ER
R. P. Siskind	1136 Beacon St., Brookline, Mass.	1ES
Dallas E. White	388 Spring St., Brockton, Mass.	1EU
Philip K. Baldwin	101 Fellsway West, Medford, Mass.	1EV
W. J. Coughlin	51 Reservoir Ave., Revere, Mass.	1EW
Frank V. O'Neill	196 Mamilton St., Dorchester, Mass.	1EY
Harry E. Upton	400 Woodford St., Woodfords, Maine	1FA
L. G. Cumming	Scarboro, Maine	1FB
Albert E. Snow	30 Cary Ave., Chelsea, Mass.	1FC
Albert E. Snow	Orleans, Mass.	1FD
Thomas A. Cochran	21 Putnam Ave., Cambridge, Mass.	1FE
Patrick J. Furlong	6 Glenside Ave., Jamaica Plain, Mass.	1FF
Arthur F. Steeves	260 Brighton Ave., Allston, Mass.	1FG
Richard R. Jordan	17½ Baldwin St., Cambridge, Mass.	1FH
Arthur T. Hovey	62 St. Germain St., Boston, Mass.	1FJ
William A. Gordon, Jr.	82 Myrtle St., Shelton, Conn.	1FL
John Marshall	9 Sherman St., Portland, Maine	1FM
Raymond S. Chase	16 Ellis St., Brockton, Mass.	1FN
Joseph A. Sjogren	33 Maltby Place, New Haven, Conn.	1FO
Bradford L. Barrett	47 Forest St., Springfield, Mass.	1FP
George F. Donnelly	Main St., So. Meriden, Conn.	1FQ
Lester I. Jenkins	923 Purchase St., New Bedford, Mass.	1FR
Harold S. Southwick	103 Green St., Fall River, Mass.	1FS
William L. Slaney	23 Midland Road, Dorchester, Mass.	1FU
Rahma W. Pratt	208 Longfellow St., Westbrook, Maine	1FV
Frank M. Ham	34 Prescott St., Bridgeport, Conn.	1FW
P. B. Wainwright	14 School St., Andover, Mass.	1FX
Harold L. Johnstone	469 Washington Ave., West Haven, Conn.	1FY
Emanuel Tarplin	325 Boston St., Lynn, Mass.	1FZ
Daniel H. Anderson	40 Oliver St., Everett, Mass.	1GA
Frank E. Reeves	87 Quincy Ave., East Dedham, Mass.	1GB
Elwood C. Forsyth	10 Porter St., Everett, Mass.	1GC
Raymond H. Power	150 Timson St., Lynn, Mass.	1GD
F. J. Donahue	113 Henry Ave., Lynn, Mass.	1GE
Carl Richardson	119 Williams Ave., East Lynn, Mass.	1GF
H. C. Dunton	17 Kidder Ave., Somerville, Mass.	1GG
L. B. Salt	11 Van Brunt Ave., Dedham, Mass.	1GH
Carl W. Erickson	21 Spring St., Everett, Mass.	1GI
George H. Hartmann, Jr.	73 Liberty St., Meriden, Conn.	1GJ

T. P. Coogan	93 Cliff Ave., Winthrop, Mass.	1GK
Gustaaf W. Von Colln	14 Flynt St., Quincy, Mass.	1GL
L. V. Cleveland	34 Pierce Ave., Beverly, Mass.	1GM
J. M. Campbell	14 Kensington Road, Arlington, Mass.	1GN
Abraham Barber	175 Walnut Ave., Roxbury, Mass.	1GO
Frank H. Chickering	23 Oliver St., Malden, Mass.	1GP
Earl S. Peckham	22 Summit Ave., Bangor, Maine	1GQ
Nyles L. Lamson	61 Marlboro St., Belmont, Mass.	1GR
Mortimer A. Neff	East Norfolk, Mass.	1GS
R. F. Fietz	130 Washington Ave., Chelsea, Mass.	1GT
Ernest H. Macurdy	23 Chester St., Watertown, Mass.	1GU
H. H. Tilley	571 Columbus Ave., Boston, Mass.	1GV
Herbert K. Nock	27 Lafayette St., Newburyport, Mass.	1GW
William J. Hill	594 East 7th St., South Boston, Mass.	1GX
Lee A. Bates	8 Moen St., Worcester, Mass.	1GY
William H. Buffington	836 Maple St., Fall River, Mass.	1GZ
Lloyd C. Greene	142 Raymond St., Cambridge, Mass.	1HA
Gerald A. Travis	59 Kenmere Road, Medford, Mass.	1HB
Harry C. Cheetham	81 Avon St., Somerville, Mass.	1HC
Robert N. Anderson	17 Middle St., Marblehead, Mass.	1HD
Robert M. Peterson	3 Blodgett Place, Worcester, Mass.	1HE
Henry E. Davies, Jr.	Box 218, Vineyard Haven, Mass.	1HF
George H. Proulx	211 Fayerweather St., Cambridge, Mass.	1HG
Cornelius J. Grin	6 Webster Ave., Bridgeport, Conn.	1HH
Elmer H. Walter	39 Cleveland St., Melrose, Mass.	1HI
Harold B. Upham	20 Mt. Bowdoin Terrace, Dorchester, Mass.	1HJ
P. Francis Hahn	St. Anslem's College, Manchester, N. H.	1HK
Lawrence R. Barbeau	110 Lafayette Park, Lynn, Mass.	1HN
George D. Mallory	173 Livingston Place, Bridgeport, Conn.	1HO
Theodore F. Leonard	587 Ferry Boulevard, Stratford, Conn.	1HP
Watertown High School	W. W. Patten, Jr., Watertown, Mass.	1HS
Henry T. Munroe	38 Beacon St., Everett, Mass.	1HW
L. S. Bennett	2 Lawrence St., Everett, Mass.	1HY
Harry L. Sawyer	31 Newhall St., Lynn, Mass.	1IS
C. Harold Campbell	66 Vine St., Bridgeport, Conn.	1IV
Leslie W. Atkinson	404 Stevens St., Lowell, Mass.	1LA
Walter J. Butterworth	7 Bagley Ave., Lowell, Mass.	1LB
Rhode Island State College	Kingston, R. I.	1YA

### SECOND DISTRICT

License issuing commenced, but QST's reports meagre. Following comprise both new calls known and authorizations for use of old calls pending receipt of license.

Henry L. Bantelman, Jr.	300 Tuckahoe Rd., Yonkers, N. Y.	2AM
Harry E. Geitz	1926 Bleecker St., Ridgewood, L. I.	2HK
Clifford J. Goette	Woodhaven, N. Y.	2JU
College of the City of New York	Radio Club, New York	2XN
Knights of Columbus	Camp Dix, N. J.	2YA
Y. M. C. A.	153 E. 86th St., New York	2YM
C. R. Runyon, Jr.	Yonkers, N. J.	2ZS
A. H. Grebe	Richmond Hill, L. I.	2ZV
R. S. Otto	Plainfield, N. J.	OTTO

### THIRD DISTRICT

Licenses being issued, but very few reports yet.

Bayard P. Fonda	1625 Locust St., Philadelphia	3AI
Norris Tuttle	Line Road, Bryn Mawr, Pa.	3AQ
John Hopkins University	Baltimore	3XD

### FOURTH DISTRICT

Georgia School of Technology, Atlanta, Ga.		4YA
--	--	-----

### FIFTH DISTRICT

New calls being assigned, and use of some old ones authorized.

Hubert E. DeBen	1044 City Park Ave., New Orleans	5AA
Jas. L. Autry, Jr.	5 Courtlandt Pl., Houston, Tex.	5AB
Clifford W. Vick	1913 Smith St., Houston, Tex.	5AC
F. C. Moore	484 Hillary St., New Orleans	5AD

John M. Clayton	1301 Welch St., Little Rock, Ark.	5AF
Donald G. Graham	Elm Grove Ptn., House, Tex.	5AG
W. H. Tilley	Austin, Tex. (Still using old call)	5AL
Paul E. Greenlaw	Franklinton, La. (Still using old call)	5BB
A. & M. College	College Station, Tex.	5YA
University of Alabama	Tuscaloosa, Ala.	5YB
Frank Reeves	Austin, Tex.	FR
Louis Falconi	Box 421, Roswell, N. Mex.	LF
	Comanche, Texas	ZY

## SIXTH DISTRICT

N. Heuter	San Francisco	6AA
W. J. Henry	San Francisco	6AB
J. W. Little	San Francisco	6AC
M. L. Webb	San Francisco	6AD
F. E. Terman	Stanford University	6AE
F. Schubert	San Francisco	6AF
E. A. Schiro	San Francisco	6AG
R. S. Ahern	Oakland	6AH
C. T. Peterson	Oakland	6AI
C. S. Mundt	Concord	6AJ
L. D. Mealer	Walnut Grove	6AK
G. F. MacMullen	Coronado	6AL
Robt. Lyon	San Francisco	6AM
R. B. Lohry	Oakland	6AN
V. C. Lytton	San Francisco	6AO
H. W. Dodge	San Francisco	6AP
A. N. Cormack	San Francisco	6AQ
P. F. Berne	San Francisco	6AR
T. B. Brown	San Francisco	6AS
E. G. Arnold	San Jose	6AT
W. A. Collins	Oakland	6AU
P. T. Nesbit	Healdsburg	6AV
Univ. So. California	Los Angeles	6YA

## SEVENTH DISTRICT

Licensing commenced.		
H. Rurfro	7319 48th Ave., S., Seattle, Wash.	7AA
Donald Craib	2146 No. 64th St., Seattle, Wash.	7AB
Vincent Kraft	Y. M. C. A., Seattle, Wash.	7AC
F. J. Bratt	10 Walk No. 1, Madison Pk., Seattle	7AD
H. Truesdell	2730 E. 53d St., Seattle, Wash.	7AG
Clarence Benzon	3641 14th Ave. W., Seattle, Wash.	7AH
Edward Billing	3232 13th Ave. W., Seattle, Wash.	7AK
Leander L. Hoyt	Hotel Cherry, Seattle, Wash.	7AQ
Lewis Webster	2568 12th Ave., W., Seattle	7AU

## EIGHTH DISTRICT

Chas. C. Candler	St. Mary's, O. (Correction)	CC
K. A. Duerk	1000 Wilhelm St., Defiance, O. (old 8AHI)	8AA
Michael D. Lyons	463 Green Ave., Detroit	8AM
Ed. Clark	Epworth Blvd., Detroit	8AO
Herbert Tank	Ferndale St., Detroit	8AR
H. P. Hardertz	396 Monterey, Hghld. Pk., Detroit	8BR
Clyde E. Darr	137 Hill Ave., Hgid. Pk., Detroit	8CB
West Virginia University	Morgantown, W. Va.	8YA

## NINTH DISTRICT

Booming. Licenses being issued as rapidly as possible.		
Francis H. Hamilton	2011 N. Alabama St., Indianapolis	FH
Cyrus T. Read	507 W. 62nd St., Chicago	9AA
Thordarson Elec. Mfg. Co.	501 S. Jefferson St., Chicago	9AB
Geo. L. Winberg	6651 Maryland Ave., Chicago	9AC
Donald Niels Buck	5332 Kenmore Ave., Chicago	9AD
Ralph Eugene Brooks	27 W. Williams St., Hammond, Ind.	9AF
H. G. Phillips	240 Sheridan Road, Hubbard Woods, Ill.	9AG
F. H. Schnell	2220 Roscoe St., Chicago	9AH
Harry A. Mackley	420 Deckman St., Peoria, Ill.	9AJ

Henry Klaus	Eureka, Illinois	9AK
Julius Amos Thomsen	3407 LeMoyné St., Chicago	9AL
Henry Flesvig	743 W. 26th St., Chicago	9AM
Fred Schoenwolf	1917 Warner Ave., Chicago	9AO
E. G. Cunningham	304 W. Washington St., Champaign, Ill.	9AP
Merwyn Street	6640 Parnell Ave., Chicago	9AQ
John Francis Scholtes	2044 Waveland Ave., Chicago	9AR
Ralph E. Foss	1321 E. 53rd St., Chicago	9AS
John Quincy Adams	5410 Fulton St., Chicago	9AT
Chas. H. Zeller	4732 N. Maplewood Ave., Chicago	9AU
Edwin Werlein	4060 Lincoln Ave., Chicago	9AV
Ralph Allen Shugart	450 E. 34th St., Chicago	9AW
C. W. Leininger	2119 N. Tripp Ave., Chicago	9AX
Richard Buckley	6206 University Ave., Chicago	9AY
Harry J. Card	2201 N. Tripp Ave., Chicago	9AZ
Ray Wilson	1432 Irving Park Blvd., Chicago	9BA
Harold J. Buckley	1104 Barry Ave., Chicago	9BB
Purdue University	Lafayette, Ind.	9YA
North Dakota Ag. College	Agricultural College, N. Dak.	9YB
R. H. G. Mathews	1316 Carmen Ave., Chicago	9ZN

### CANADIAN

As there is no official list of amateur calls in Canada, we invite our friends across the Line to make QST their directory too. We have record of the following

#### Canadian calls.

J. D. Jarest	Levis, Que.	2AB
K. Russell	353 Markham St., Toronto	3AB
C. Duncan	71 Vermont Ave., Toronto	3AC
C. Hill	Weston, Ont.	3AD
D. Heustis	54 Huntley St., Toronto	3AH
H. B. McKenzie	145 Warren Rd., Toronto	3AL
K. S. Hall	1502 Dufferin St., Toronto	3AO
P. Bernard	122 McGill St., Toronto	3AT
E. B. Sisley	1363 King St., W. Toronto	3BF
W. D. Brown	157 Cumberland St., Toronto	3BL
E. S. Rogers	49 Nanton Ave., Toronto	3BP
J. R. Fenwick	167 Close Ave., Toronto	3CA
T. Welsman	14 Walmer Rd., Toronto	3CD
W. R. Carruthers	5 Wells St., Toronto	3CE
W. F. White	786 College St., Toronto	3CI
T. D. Churchill	213 Quebec Ave., Toronto	3CK
Silas J. Metzler	Middle House, Burwash Hall, Toronto	3CR

## CALLS HEARD

Here we are, Gang. This unimposing little column will henceforth be the very centre of attraction in QST. It's small this time because the reports had just begun to roll in when we had to give our list to the printer. We've a great stack of them for next QST. How about a list of those you hear? Let's have 'em!

Heard at 5AL, W. H. Tilley, Austin, Tex.: GC (QSA very), 5EW, VD, 9PW, 5BP, 5BV, 5BB, 5AX.

Partial list from 9ZN. Worked: 9NE, 9JW, 9VP, 9ST, 9HN, 9NN, 9XU, 9NH, 9AHL, 9ADX, 9AA, 9JZ, 2WB, 2ZS, 2CS, 5AF, 5AC. Also heard: 9DC, 9OY, 9AJ, 9PO, 9HU, 9AN.

C. W. Vick, Houston, Tex., reports: 5BB, 5BV, LF.

M. D. Lyons, 463 Green Ave., Detroit, call ML, reports 9XU, 9HN, 9ZN, 9AJ, 9AHL.

Heard at 9AP, formerly GR, E. G. Cunningham, Champaign, Ill.: 9AK, 9SX,

FW, CC, MK, SSH, 5BV, 5BB, UN, JS, BR, GB, FH, DD, 9AS.

Heard at 5AA, Hubert E. deBen, New Orleans: 5AF (5BV), 5BB, 9AHL, 9ZN, GH, GC, CV.

F. C. Moore, 5AD, New Orleans, reports 5BV QSA on galena.

Heard on Ye Editorial Set at Hartford, where we haven't had time to listen a good hour total time as yet: 9AHL, DAU, 2ZS, 2DA, 2BB, 1FQ, 8CC, 3BZ, 8JZ, 1BZ, 9AUM, 2IR, 1GK, 9BR, 9AMN, CC-8NH, WID, WK.

### ERRATUM

In QST for November, on page 11, the impedance of the primary winding of the Acme amplifying transformer was stated as approximately 1000 ohms, and that of the secondary about 6000 ohms. These figures are the D. C. resistance, and the impedance is much higher, that of the primary at 800 cycles being approximately 30,000 ohms.





## SPREADING OUT

The letter in another column from Mr. Walker at Vancouver, B. C., will start many of us thinking about the international aspects of our A.R.R.L. We here at Headquarters have heard the rumbling of Canadian co-operation for some time. We expected some day the thing would come about. Like everything in amateur radio it came quicker than we thought. It is here now. The Traffic Department have given the subject some attention already, because we all recall the frequent mention in Mr. Entwistle's reports of what he was doing with our Canadian cousins. But now it is getting about time to begin to plan for something regular in Canada. Evidently we shall shortly be working Canadian amateurs just as we work those in our own land. Once we get this sort of thing working smoothly it is evident that on the west coast we shall soon be spilling over into Alaska, our own U. S. A. again. Then will be seen the unique situation of relaying messages out of our own country, through a foreign land and back into a distant possession of ours. It will certainly be a great triumph for amateur radio if we are to be the first ones to be able to handle traffic into and out of Alaska free of charge. We sure see some of the professional gentlemen down in Washington scratching their heads when they hear about this. And it will come to pass, too. If there is one thing Alaska wants it is quick and free communication. There are no roads, no highways of regular traffic, no telephones every few yards, and mighty few telegraph lines. All the more

reason why the inhabitants can be made to see the advantages of wireless. And they are a progressive lot. They have to be or die. When once it is borne in upon the rank and file of young Alaska that a wireless station is an easy matter for him and will put him into instant touch with his fellows and also with the rest of the world it will not take him long to commence operations and to learn the code. Probably our QST with its amateur standards and the atmosphere of good fellowship will be the means of getting the gospel of citizen radio started in Alaska. Heaven knows they need it. How long would you or I be living in Alaska without a wireless outfit, where throughout a larger part of the year it means terrible exertion to even get near enough to one's next door neighbor to talk to him.

If we cross the Canadian border, how about establishing Divisions, and Division Managers, District Superintendents, etc., etc.? It ought to be systematically organized, certainly, and not let to grow up all criss-cross by itself. Shall true democratic methods be followed as they are here? Shall Canada be asked to lay out her amateur radio to suit herself, and simply tell us where we are expected to hook on? Of course we can co-operate with advice to whatever extent we are asked. It is one of the things that is going to call for a conference and we look forward with the keenest pleasure to the spectacle. Come on, you good fellows up in the Northland. We're with you. Organize, get together, and call on us for any thing you want.

## ***SLOW STARTING***

From our semi-detached position in the editorial chair we cannot refrain from a sly smile at the time being taken in getting going again. Before we were opened up everybody seemed to have everything all ready for the word to go. But when the word came there seemed to be a lot of fixing up that was necessary. We do not have any time ourselves to do any real operating but we manage to keep pretty close to the thing just the same. We notice a terrible lot of CQing from those few who can transmit and precious little answering. Our location is not the equal of New York or Chicago, but nevertheless there are some radio bugs hereabouts. We have the notion that the real radio men only started getting ready after the lid was lifted and that at the present time a huge amount of work is going on putting up masts and getting the heavy outside stuff rigged. When it is considered that a man spends about as much money on his outside rig as he does on his inside you can figure out how much money is being spent. It will go into the millions, fellows.

We heard one dealer offer to lay a bet that his house would sell two hundred thousand dollars worth of receiving and transmitting apparatus during the year 1920. The bet was not taken.

We are told that in the middle West and also in the New York district things are going fairly briskly, but even there we would like to venture the guess that it isn't a circumstance to what it will be when all the fixing has been done. Everybody has an altogether more elevated idea as to what he wants. This not only applies to the apparatus but to the masts. Where two wires from a tree to the top of the house was good enough before the war it is nothing but an eightly foot mast and not less than seven wires that are demanded now. It takes time and money to have these things but as there seems to be plenty of both it appears as though only the sky is the limit. Amateur radio is a different game, fellows, than it was before the War. She's coming with a rush and it will take your breath away in just about six months from date. Watch and see.

## ***RADIO CLUBS***

In these hectic days of trying to get going with something really good, don't overlook the matter of the value of a Radio Club. We know whereof we speak, because we have seen the dark days of going it alone, playing the lone radio hand, and we have seen the brighter days when once a week we have rubbed elbows with others who are interested in the same problems that are perplexing us. The opportunity to talk things over is invaluable and many times it is our own idea which is the good and new one but we never would have thought of it if we had not been stimulated to it by the discussion with the other fellow. Then again, it frequently happens that the other fellow knows a little more about something than we do and we learn something we did not know before. Everyone who has any radio

club experience knows the truth of this. So we say, go to the club idea all you fellows who are trying to go it alone. Never mind if it takes a little nerve to butt in. It is worth it. We know of one young fellow who had to walk a good seven miles out into the bush after every radio club meeting in order to get home. He was the stuff that makes real men. His idea was that it was worth it to him.

The value of the Radio Club is more than the help it gives to the individual members by providing the opportunity to talk things over. It makes for strength of Amateur Radio generally. Once there is a Radio Club formed it gets into the papers and the thing begins to acquire an individuality, Wireless matters begin to be talked about generally by others than the amateurs themselves, and finally a day

comes when public sympathy is wanted. Then is the time that people think of the little Radio Club, and remember its little but serious efforts, and are more than likely to insist upon its having a square deal.

We cannot advise too strongly that in all localities where there are a few wireless enthusiasts, they get together and organize a club and arrange for regular

meetings even if it is only for conversation. We know that in half an hour the discussion would commence to be of value to all concerned. We are in a position to help by advice in these matters and if any group of fellows wants a lift in getting things started, write in and we will tell you a lot that there is not space to retail in these columns.

## OUR DUTY

We want to repeat our warning of a month ago. Be mighty careful about this interference business, Friends. It is our observation that a considerable number of unlicensed stations are in operation on just any old wave length and in a fair way to cause interference at commercial and government stations. Unlicensed stations are bad medicine; operation without going through the formality of applying for a license and securing temporary authority to work is illegal. Even with such authorization, however, there is no authority for exceeding 200 meters. We believe all these potential interferers are "punks" of the sort who do not read our QST and who

therefore are not aware that they are pressing the key where angels fear to operate. For that very reason it is up to us to look after them and to do everything possible to see that they do not violate the law. There will be no interference by a station which complies with the existing law—there can't be. Our duty is to look after these one-circuit folks, these too-high-wavelength stations, these license-disdainers, one by one, and see that they get right. The good name of amateur radio demands it. Our logs must not show commercial stations yelling their heads off at unlicensed punks to "QRT—QRM 550 meters." Give the J. O. a helping hand!

## On Handling Traffic

By Edward A. Gisburne

**B**Y studying one of the standard textbooks on radio telegraphy it is possible to scrape a first rate acquaintance with Old Doc Theory and quite a number of manufacturers turn out apparatus which is scientifically correct. It is easy enough to equip a station; the question is, "Are you a good operator?" And I am thinking as I write of the thousands of birthday greetings that in the good old days before April, 1917, got about twenty-five miles from home and are now sleeping peacefully in someone's old files. How many times have you heard a plaintive "QSL pse" flutter through the ether? And which station was to blame?

One of the chief qualifications of a good radio operator is his ability to select or make good apparatus for his station. By good apparatus I mean, speaking of receiving for example, a set which is sen-

sitive without being critical, which tunes sharply without a multiplicity of tuning devices and which is, above all, capable of giving service day in and day out without tinkering at its vitals to keep it on the job.

We all know the fellow whose receiver brings in 8NH loud enough to knock the house down, but the displacement of atmosphere caused by one good, deep breath will cause the signal to fade. We are also acquainted with the fellow who, when shifting from 200 to 201 meters, has to adjust four condensers, three inductances, two couplings and walk around his chair. I maintain that such sets are not good ones, however sensitive or selective they may be, because they are clumsy and unreliable.

In the naval radio station of which I had charge during the war there were, includ-

ing myself, five operators; all of course using the same receiver, which I devised to meet the strenuous requirements of war-time communications. While using this receiver every word copied was taken directly on a typewriter, including signals from Cadiz, Spain, EAC, (3900 miles), signals from Cape Race and Keywest at about noon, and many long series of messages from vessels 2000 to 2500 miles distant. From November, 1918, to March, 1919, the station received about 300 messages daily with no receiver trouble. The receiver which did this work had only three adjustments and one of these sufficed for most tuning.

If A. R. R. L. operators will avoid "phoney" hookups and develop to the limit the safe and sane dependables, we should handle traffic in a most dependable manner. Amateur relay stations have done far better work, all things considered, than commercial stations; but in my opinion "critical" receiving apparatus has prevented more and better relay work.

Before making a call or a transmitter test listen in carefully, not perfunctorily, to make it sure that you will not interfere with traffic. If someone with whom you are likely to interfere is working, stand by

until he is through. Observance of this as a hard and fast rule by all operators who handle relay work from 9 to 12 each night will do wonders toward relieving a QRM situation which in April, 1917, had reached almost the height of aggravation. Operators who have transformers should use low power and finish "chewing the fat" by nine o'clock. I can recall many occasions when two fellows with half kilowatt sets, living three or four blocks apart, jammed the air with silly chatter at three and four A.M. while others were striving for long distance records.

When communication is established with another relay station transmit your traffic at a moderate speed—about eighteen words a minute—and transmit clearly. Do not repeat words unless requested to do so. Many operators rely upon the judgment of the man at the receiving end to decipher slurred and run-together characters. A very bad habit is formed in this way.

A universal form for relay work will be a great boon. It is my opinion that the check in amateur work is superfluous. The following form is suggested: Number, place of origin, filing date, call letters of station received from prefixed by "via".

(Concluded on page 37)

## An Experimental Busboard

THE average amateur and experimenter does not desire a permanently connected set, but, rather, individual instruments permitting the use of various hookups, and here is a novel idea for such work.

A sort of permanent busboard is wired up, either flat on the table or perhaps more conveniently on a vertical panel at the rear of the table, after the manner shown in A in the illustration, using separable connectors such as the Mesco No. 6493 "Midget" as sketched at B. The bases of these connectors can be inserted in  $\frac{5}{8}$ "

holes so as to mount flush, and the plug ends can be attached to the various pieces of apparatus by flexible leads. In this manner any desired hookup can be quickly and conveniently obtained by simply plugging in the required equipment at the proper points in the circuit.

In C is shown one of many hookups possible. Note that a number of short-circuited plugs should be kept handy to bridge some of the idle connections.

Credit for this idea is due Mr. Ernest Oke, of Peterboro, Ontario.

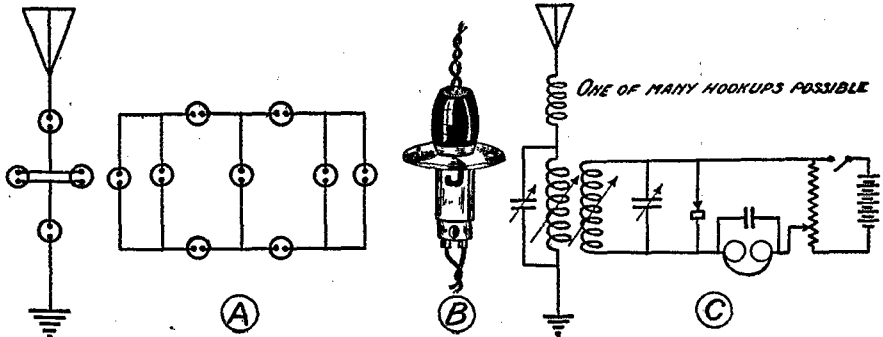

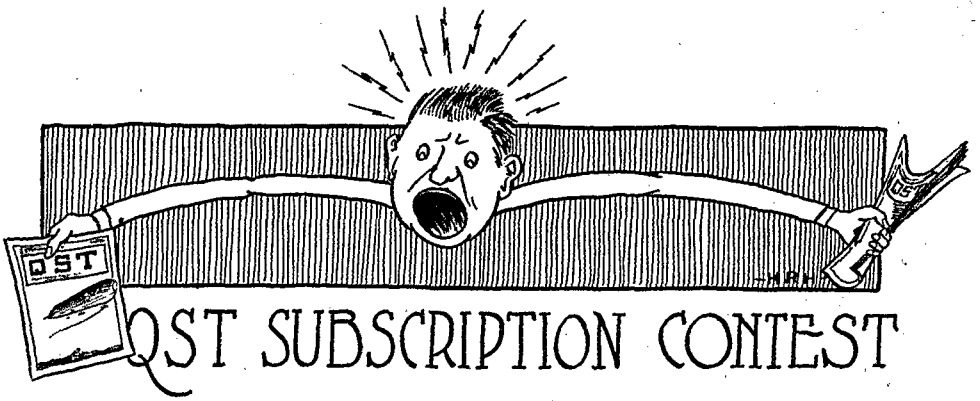

# QST SUBSCRIPTION CONTEST

## CONTEST NOTES

**T**HE contest starts off with a bang. November QST has been out just a short while, on this date when it is necessary for us to cook up the material for our December number, but in these few days the Early Birds have sent in their names and are getting action.

One of our A.R.R.L. Division Managers, who incidentally walked away with First Prize in one of our former contests, writes us: "Put me down for first place in your QST Subscription Contest, OM, for I'm out for blood! Need the apparatus the worst sort of a way and believe me, with the bunch of friends who helped me out in the first contest ready to back me up again, I'm ready to bring home the bacon for both QST and myself." Now the question is, are you going to let him get away with it like that? Another contestant has conceived the happy idea of talking subscriptions from his friends by wireless, and already his first 48 points are credited at this office. A complete list of scores will appear in next QST.

Whoop her up, you chaps, and get going. The first workers in each community get the easy pickin's, and you don't want somebody else to scoop up this gravy in your village. Take a slant at the costs of good apparatus these days, and let QST buy you what you need. The first step is to send in your name for enrollment and get a supply of blanks. Do it right now.

The Contest Manager.

Here is what you have been waiting for. To many of the most enthusiastic amateurs, first-class apparatus is out of reach financially. With the idea of helping these amateurs, who may become leading relayers, QST offers a proposition whereby instruments of the very highest type may be earned by a little work at getting subscriptions. QST subscriptions may be had for the asking. Try it and see.

In our former contests we had definite prizes, announced beforehand, and while the prizes were all apparatus of unquestioned quality it had the bad feature that a contestant might win a rotary gap when he already owned one and would much rather have a hot wire ammeter listed as a prize lower down in the list. So in this contest we've thought of a better idea. We're not going to specify any definite apparatus, but instead the prizes are money values which we will invest for you in any apparatus you may choose from the catalogs of any of the manufacturers listed. For instance:

The contestant who sends in the largest number of subscriptions before February 10, 1920 wins the First Prize of \$50.00 worth of apparatus. We will purchase for him any apparatus he may desire, up to a total of \$50.00 catalog value, from any of the manufacturers listed. Or, if he desires some special piece of equipment listed in excess of \$50.00, we will purchase that for him if he will send us a remittance to cover the difference.

For the one who sends in the second highest number of subscriptions, we will purchase \$30.00 worth of apparatus, whatever he

may select, from the catalogs of any of these manufacturers, or allow credit for that amount in the purchase of more expensive apparatus.

The third, fourth, and so on up to the twentieth, receive the amounts listed below. Look it over.

The conditions are not complicated. They are simply:—

1. Send in your name and address and we will send you some subscription blanks. To be entered in the contest, your subscriptions must be sent in on these blanks. Be sure to write your OWN name on the back of each blank so that we know whom to give credit.
2. To be entitled to any of the first ten prizes, you must send in a minimum of 15 yearly subscriptions or their equal. To be entitled to any of the last ten prizes, you must send in a minimum of 10 yearly subscriptions or their equal.
3. Any one is eligible, whether a subscriber or not.
4. Twelve credits are given for each yearly subscription. Short term subscriptions are counted in proportion. Extensions of existing subscriptions and renewals count the same as new subscriptions.
5. All subscriptions must be in this office before midnight February 10, 1920. If received later, they will not be credited.

Scores will be printed monthly in QST so that you will know how you stand compared with the other entries. We will be pleased to tell you your score at any time by mail, send you more blanks, or help you in any manner possible.

Remember that you're actually doing folks a favor when you induce them to subscribe to our QST. QST is 100 per-cent amateur radio, and is the only genuine monthly joy-bringer "of, by, and for the amateur." Subscriptions will sell like hot-cakes. All you have to do to sell a "bug" is to shake a QST in his face and show him where to sign. Another thing which will help you is that there actually exist

a lot of former readers whom we haven't been able to tell the good news that QST has reappeared, and the least intimation of your purpose should bring forth their little old one-fifty, pronto. But don't content yourself with the amateurs in your own town alone. Write all the fellows you know, for it's subscriptions that count for you. Don't forget that the most unexpected folks are often good prospects, just itching to hitch up with a good amateur magazine—which means us. Your best girl's brother's second cousin may be interested, and you don't want to miss any bets. Everybody starts out with an equal chance, but the hardest workers will be the winners. Are you on?



DON'T MISS LINING UP EVERYBODY AT THE CLUB

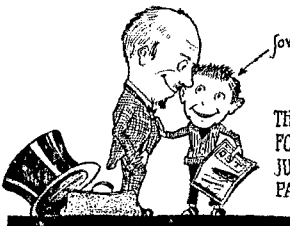

THE MOST UNEXPECTED  
FOLKS ARE PROSPECTS  
JUST F'INSTANCE THE  
FAMILY DOCTOR

## BEST AMATEUR APPARATUS IN AMERICA --- FREE !

Here are the prizes. Prices for good apparatus naturally are higher than before the war, and now is your chance to have what you need handed to you free. Just scan this list and think what it will buy for you. Regenerative sets, amplifiers, head-sets, variometers, condensers, detectors, V. T's., storage batteries, loose-couplers, transformers, rotary gaps, meters, switches—just exactly whatever it is that you most need to equip your station.



MAKE IT BE YOUR NAME THAT THE EDITOR PUTS ON THIS ORDER

THE PRIZES						
1st Prize, \$50.00	worth	of	apparatus,	catalog	prices.	
2nd	"	30.00	"	"	"	"
3rd	"	25.00	"	"	"	"
4th	"	22.00	"	"	"	"
5th	"	18.00	"	"	"	"
6th	"	15.00	"	"	"	"
7th	"	12.00	"	"	"	"
8th	"	10.00	"	"	"	"
9th	"	8.00	"	"	"	"
10th	"	7.00	"	"	"	"
11th	"	6.00	"	"	"	"
12th	"	6.00	"	"	"	"
13th	"	6.00	"	"	"	"
14th	"	6.00	"	"	"	"
15th	"	5.00	"	"	"	"
16th	"	4.00	"	"	"	"
17th	"	3.00	"	"	"	"
18th	"	3.00	"	"	"	"
19th	"	3.00	"	"	"	"
20th	"	3.00	"	"	"	"

And here is the list of manufacturers from whose catalogs you may select your prizes, choosing exactly what you wish from any number of firms. All you have to do is to send us a list of what you want, giving

the manufacturers' catalog numbers, and will have the apparatus shipped you direct. You can't go wrong on any of this equipment. The firms are the best in the art and their products are recognized as a standard. If you haven't their catalogs, write for them. These manufacturers make

PIPE THE BEATIFIC SMILE

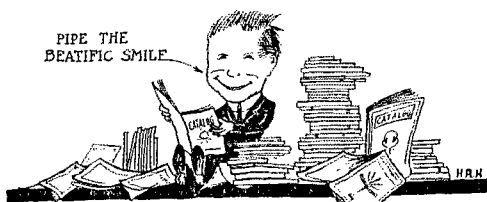

OODLES OF CATALOGS FROM WHICH TO CHOOSE

---

## The Best Amateur Apparatus In America

---

Acme Apparatus Co.,	Cambridge, Mass.
American Radio & Research Corpn.,	New York City
Arnold, J. F.,	New York City
AudioTron Sales Co.,	San Francisco
Barr Mercury-Cup Detector,	Washington, D. C.
Brandes, Inc., C.,	New York City
Bunnell & Co., J. H.	New York City
Burgess Battery Co.,	Chicago
Chicago Radio Laboratory,	Chicago
Clapp-Eastham Co.,	Cambridge, Mass.
Connecticut Tel. & Elec. Co.,	Meriden, Conn.
DeForest Radio Tel. & Tel. Co.,	New York City
Federal Tel. & Tel. Co.,	Buffalo
Firth & Co., Inc., John,	New York City
General Radio Co.,	Cambridge, Mass.
Grebe & Co., A. H.,	Richmond Hill, L. I.
International Radio Tel. Co.,	New York
Klitzon Radio Mfg. Co.,	Racine, Wis.
Manhattan Electrical Sup. Co., Inc.,	New York
Marconi Wireless Tel. Co.,	New York City
Murdock Co., Wm. J.,	Chelsea, Mass.
North American Aerial Spar Mfg. Co.,	Dubuque, Iowa.
Precision Equipment Co.,	Cincinnati
Radio Distributing Co.,	Brooklyn, N. Y.
Radio Engineering Co.,	Baltimore
Radio Equipment Co.,	Philadelphia
Shotton Radio Mfg. Co.,	Scranton, Pa.
The Wireless Shop,	Los Angeles
Thordarson Elec. Mfg. Co.,	Chicago
Tresco,	Davenport, Iowa
Tuska Co., The C. D.,	Hartford, Conn.
Universal Radio Mfg. Co.,	Elmira, N. Y.
Watkins Manufacturing Co.,	Wichita, Kansas
Wilcox Laboratories,	Lansing, Mich.
Wireless Improvement Co.,	New York City
Wireless Specialty Apparatus Co.,	Boston

---

Address all communications to

**THE CONTEST MANAGER** American Radio Relay League  
Hartford, Conn.



## WHO'S WHO IN AMATEUR WIRELESS

We shall publish each month two pictures of amateurs who have become known to us in our work. This will draw us all closer together. We are often curious as to just what the other fellow looks like, and here's our chance to see.— Editor



**JAMES L. AUTRY, JR.**

Jimmie Autry, our w.k. A.R.R.L. Superintendent for the District of Southern Texas, has been staggering around since the age of thirteen with that incurable malady—radioitis.

He was born in Corsicana, Texas, in 1899, but moved to Houston, which has since been his home, at the age of nine. For two years he was the only amateur in Houston, but those happy days didn't last long. "After that", as he puts it, "the number grew rapidly." 'Zever thus. During the war he was enlisted in the S.A.T.C. at Rice Institute, Houston, and at the time of the armistice was an appointee to the Air Service Radio Officers' School at Columbia University. He is now in his third year in Electrical Engineering (notice capitals) at Rice Institute.

His station, 5ED, was heard in twenty-two states during the winter of 1916-1917, and in common with several thousand more of us he is now preparing to smash all the records of that memorable season.



**J. C. COOPER, JR.**

This calm and self-possessed-looking gentleman is our East Gulf Division Manager, Mr. J. C. Cooper, jr., of Jacksonville, Fla.

Mr. Cooper was born in Jacksonville in 1887, graduated from Lawrenceville School, Lawrenceville, N. J., in 1905, and from Princeton University with his A. B. degree in 1909. Notice that placid brow? 'Sunny, because he is a lawyer, having been admitted to the Florida bar in 1911. One of the dyed-in-the-wool brand of amateurs, when war broke out he possessed exactly those qualities necessary in a radio executive, and was commissioned Ensign, U. S. N. R. F., May 17, 1917, acting first as Assistant to the District Communication Superintendent at the Charleston Navy Yard, until September 1, 1919, when he was transferred to Washington in the office of the Director of Naval Communications, where he served until released from active duty March 1st last in the rank of

(Concluded on page 25)

## “ STRAYS ”

A Navy radio operator was trying to impress his friend, a musician, with the dangers of his position—how he must remain faithfully at the key pounding out SOSes if the ship struck a mine, while the rest of them got into the boats, etc. ad lib. “Pipe down”, said the musician; “there’s ten of you sparkers on this frigate, so you’ve just one chance in ten of being on watch if we hit anything, while me!—I’m supposed to stand down on the deck and play ‘Nearer My God To Thee’ until the water gets up in my cornet.”

At last a cheap and good motor-generator set for high-voltage D. C. has arrived, and naturally is advertised in QST. Its lack heretofore has been the big drawback to amateur VT transmission, and this set is specially designed for that purpose. Owners of Marconi Class II tubes and “salvaged” VT-2’s—here is what you need for the CW transmitter.

Cecil F. Butcher, formerly 5BP of Dallas, Tex., and later operator in charge of 5ZC, has been discharged from the Naval Service and is now making his home in Greenville, Tex., where he states he will be right in the relay game as of old.

Mr. George Eltz, jr., variously known as Shorty Eltz and What Else, Chief Engineer for Clapp-Eastham Co., Cambridge, Mass., Past President of the Radio Club of America, and former amateur of prominence, was married on November 11th to Miss Marie Doody and a farewell dinner in his honor was given him by his friends at the Hotel Astor, New York, on November 8th. Formerly a Western Electric engineer, Mr. Eltz helped to install the radiotelephone equipment at Arlington used in the long distance tests with Honolulu and Paris, and during the war served as Research Radio Officer at U. S. Naval Radio Laboratory at Norfolk and later as a Naval Aircraft Radio Officer in England.

Paul M. Deeley and R. Woods, of old 5YG, Waco (Texas) High School, have deserted the amateur game for the Merchant Marine. We can say this such: the Merchant Marine has gained two good operators, and we regret very much to lose them in our relay work but wish them success in their new field. Henry M. Harris of Waco promises to keep Waco on the map as far as concerns relay work, which we believe he can do from the description of his set.

A new wrinkle in amateur radio is the RVA Service conducted by J. Donald Vandercook at Lombard, Ill., whereby responsible amateurs thruout the country may purchase radio apparatus and supplies of any make on the installment plan. They publish each month The RVA Bulletin, an attractive 8-page booklet, for the purpose of keeping in touch with their friends and customers. The application of the installment plan of selling is a new one in our field, but we see no reason why if properly handled it should not prove a success and from what we hear the RVA Service evidently is a success.

Measuring the natural period of an antenna circuit is often a most trying proposition, and it is hard to eliminate direct inductive effects on the wavemeter from leads when an attempt is made to excite the circuit by inserting a battery-operated spark-coil and gap, or buzzer.

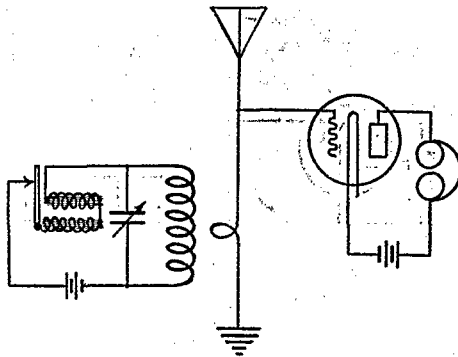

The following figure illustrates a very easy method of accurately making this reading. The wavemeter is excited by a buzzer, and is loosely coupled to the antenna circuit. A unilateral connection to the grid of an audion detector is employed, and loudest response in the 'phones is secured when the wavemeter period equals that of the antenna circuit.

Mr. Robert F. Gowen, Radio Engineer for the deForest folks, has a powerful VT transmitter at his home in Ossining, N. Y., and operates every night on 750 meters with the call HRL, using telephone, undamped telegraph, and modulated telegraph. Amateurs within a hundred miles should receive him without much trouble, and Mr. Gowen would like to hear from those who do.

Dr. James Harris Rogers, of Hyattsville, Md., on October 31st was awarded the Silver "Inventor's Medal" of the Maryland Academy of Sciences in recognition of his perfection of underground radio transmission.

During the tropical storm which swept the lower Texas coast in middle September resulting in the destruction of Port Aransas and immense loss of life and property at Corpus Christi, Clifford W. Vick, sometime CV, of Houston, Tex., rose to sudden fame and overnight became a celebrity in his home city. Vick is a typical American amateur and of course was on the job at his station, and gave the Houston newspapers the surprise of their lives when he was able to get more real news on the hurricane than any of the national news agencies. In fact he gave to the people of Houston the first authentic information of the storm's location and of the destruction taking place. And when the hardened newspaper men went out to investigate, Vick drove in some good hard licks for amateur radio and showed them the value of amateurs to the community and how much better work he would have been able to accomplish had the restrictions on transmitting been off at that time. Well done, CV.

Now we need an adapter, to accommodate the AudioTron in the standard 4-point socket. Won't some kind manufacturer oblige? Guess we can make 'em, tho: a short length of brass pipe to fit the socket, with a pin on the side, four contacts of brass rod properly spaced inside it and held by filling it up with sealing wax, with leads run thru to connect to the AudioTron. Some experimenters, we note, are sticking the end of the AudioTron into the brass pipe and running the wax around it, firmly holding it in place when the element leads are pulled tight down the sides of

the glass and soldered to the leads coming from the contacts. Another scheme is to implant a small fibre strip in the base and use it as a panel for holding the AudioTron in the regular manner, either by a spring clip or supported by the leads alone. This panel should be about 1½" wide by 4½" long, with a projection of narrower width anchored in the base, and the contact leads run up the back to the customary binding-posts.

The lid on British transmitting hangs on, but gradually "Dora is dying", they say. "Dora" is the term facetiously applied to the Defence of the Realm Act, which as a war-time measure still prohibits lots of things including British "W/T" but receiving stations are being licensed and popular opinion seems to be expediting Dora's demise.

Try a magnet on your bulb. Not a commendable thing around a relay station, but interesting, and often the sensitivity is increased amazingly.

With interest we note the reappearance of Mr. Verner Hick's little monthly, "The Radio Amateur", published in Marion, Ill., and are glad to see it improving. Keep up the good work. QST welcomes you as a helper in the cause of Amateur Radio.

Lots of new rotary gaps these days, and most of them are vast improvements in design when compared with our pre-war models. The general increase in knowledge which we picked up while in Uncle Sam's service has surely resulted in big strides forward in amateur standards. A most interesting new rotary is the Benwood, advertised elsewhere in this QST. It seems well designed, sturdy, convenient of adjustment, and almost quiet. Looks good.

### J. C. COOPER, JR.

(Concluded from page 23)

Lieutenant, U. S. N. R. F.

From August 1, 1918 until his discharge he was in charge of the Transatlantic Radio Service, handling all radio messages with England, France and Italy. He was right on the job during the hearings of the radio bill which last winter threatened the existence of amateur wireless, and because of a thorough appreciation of amateur activity acquired in his pre-war days he was able to materially assist in making known to the Committee the true nature of amateur operation.

On his return to civilian life Mr. Cooper resumed the practice of law in Jacksonville as a member of the firm of Cooper,

### "S. O. L."

(Concluded from page 7)

from bad to worse till finally I was standing a dope watch with the gobs. Of course by this time my services as a blueprint artist had become obsolete. I was fast becoming null and void because I had known too much. I shouldn't have known anything in the first place. I can see that now, but of course it's too late now.

(To be continued)

Cooper and Osborne. He is a Director of the A.R.R.L., and the East Gulf Division is rapidly lining up for efficient relaying under his able management.

# Radio Communications by the Amateurs

The Publishers of QST assume no responsibility for the statements made herein by correspondents.

## NORTHWARD, HO!

Vancouver, B. C.  
Oct. 30, 1919.

Dear Mr. Maxim:

This letter is for the establishment of a trans-Canada trunk. You may remember me as Vice-President of the New England Amateurs Association, where I was associated with Mr. Entwistle for a long time. I believe that I had the pleasure of dining with you at the Elks in Boston, in those good old days before the war, when we used to hear our friends 2AGJ, 2PM, 1CM, 1ZM, 8NH, etc., almost every night. In Canada, as you know, we are opened up once more, with fewer restrictions than before. Although I am a long ways from Boston, am just as enthusiastic as ever about amateur radio.

At my own station I am using a three stage amplifier on the receiving set. My transmitter is restricted to one-half KW. Still it will help, as I think I will have no trouble in working the amateurs across the border, a distance of about twenty-five miles. Seattle is about seventy-five miles in an air line from here, over water, and I see no reason why I will not be able to work with the hams over there. The association is installing a one KW quenched gap set, for transmitting, and we are trying to get a special 1600 meter wave. At present we are awaiting reply from Ottawa. With this set we should be able to make ourselves heard. Vancouver is an ideal point for a collecting station, as we can get all the traffic from Vancouver Island from Nanaimo, fifteen miles across from here. We are trying at present to locate a station on the northern end of Vancouver Island, through which we will be able to work Anyox, B. C. There is a two KW private set at Anyox owned by a pulp mill, not officially a two KW but I have first hand information that it is. Anyox is in communication with Prince Rupert, and Prince Rupert is only twenty-five miles or so in an air line from Ketchikan, Alaska. So, if the A.R.R.L. wishes to develop Alaska, I think that we will have this trunk working by the time that the American Amateurs are transmitting.

One of the members of the Association has a brother, also an old operator, about one hundred and eighty miles east of here.

We expect to make his station our first jump on the trans-Canada trunk. We intend to follow roughly the path of the C.P.R. across the mountains. Of course, this will take time, as we will have to locate a large number of stations, but we will keep working at it. I am drawing a little free hand map of the district, and our proposed lines, on another sheet of paper. If you think that the A.R.R.L. can make use of our Canadian sets, you may be sure that we will help out to the best of our ability. A letter addressed to William G. Walker, President of the Radio Association, University of British Columbia, Vancouver, B. C., will find me O.K. Yours for the success of the A.R.R.L.; 73's.  
William G. Walker.

## FROM AN IMPACT EXCITATION EXPERT.

Cutting & Washington  
6-8 West 48th St.,  
New York, N. Y.  
November 10, 1919.

Editor of QST,  
Hartford, Conn.

I was greatly interested to read the remarks in the October issue of QST regarding impulse excitation, and somewhat amused at the experiment along this line mentioned in the November number. Cutting and Washington having probably built more true impulse excitation radio apparatus than any other organization I feel tempted to clear you up on one or two points which seem to be misunderstood.

You are correct, of course, in saying that with true impulse excitation the energy from the primary is transferred to the secondary in one "kick". This stage has been attained as proven by numerous oscillograms taken at radio frequencies (N=500,000) by myself and others. See Proceedings of the Institute of Radio Engineers, December, 1918.

The prime requisites for this type of energy transfer are:

- Extremely close coupling—much closer than can be obtained with any normal amateur antenna operating at or near 200 meters wave length.
- An exceedingly "soft" primary. For 600 meters the primary condenser should be about one-sixth of a micro-

farad (0.16 mf) and the primary inductance 1 microhenry.

- c. A very short gap, two thousandths of an inch being about the right value. This is much closer than it is possible to run a rotary gap—less than the thickness of a piece of newspaper.
- d. Electrodes made of some extremely non-volatile metal such as tungsten.

The gap may be said from one point of view to quench perfectly. There are several causes which contribute to the quenching or de-ionization of a gap:

- a. Close coupling, so that the energy is rapidly removed from the primary into the secondary.
- b. De-tuning, so that the antenna circuit "bucks" the gap circuit by getting out of phase and producing a counter emf.
- c. Good cooling to condense the metallic vapor present in the gap.
- d. A non-volatile metal, so that the least possible amount of metallic vapor is produced.
- d. Large parallel surfaces, so that owing to the viscosity of the air between the plates a pressure wave is formed which does not have time to emerge from between the surface before the next spark is due thus increasing the breakdown potential required for the next spark.

As for the statement that there should be no period relation between the two circuits, if true impulse excitation exists this is easily shown to be manifestly in error. To reduce this to an absurdity, can you imagine a primary at the period of 25 cycles transferring much energy to a secondary of a period of 1,000,000 cycles. Make a sketch of it. The primary is bucking the secondary as much of the time as it is helping it, and during one cycle of the primary it is doing both these things forty thousand times. Or take a primary with even half the period of a secondary, the primary current would then not have its usual tendency to pass through zero and quench as the back emf from the antenna circuit would tend to prolong the first half cycle of the primary.

There is nothing sacred about the ratio of 1.7:1. Anywhere from 1.4 to 1.7 is about equally good. In plain language, this adjustment works best because the two circuits are near enough together to effect a good transfer of energy during the first part of the phenomenon and are far enough out for the secondary to rapidly become thoroughly out of phase so as to "buck" the primary with its back emf and "put out" the gap.

It is impossible to obtain sufficient quenching with a gap over .003 of an inch long unless hydro-carbon vapor is used and even then .005 will be found too much. These very short clearances make it ex-

tremely difficult, if not impossible to build a rotary gap which will answer.

The maximum voltage of such a gap is of the order of 400 volts. As you know

$$W = \frac{N C V^2}{2} \text{ max.}$$

Now the maximum  $C_p$  for 200 meters is about 0.04 mf on 60 cycles with the usual sparking of twice the cycle  $N$  would be 120, so that  $W$  would be equal to  $120 \times 4 \times 10^{-6} \times 16 \times 10^6$

$= 0.38$  watts; using two

2

gaps of the same sort in series  $W = 1.5$  watts. The answer is to use a great many sparks per cycle, in this case 330 would be required for  $\frac{1}{2}$  KW. These sparks, of course, arrange themselves into groups, each spark giving the antenna a boost and the tone frequency is identical with that of the feed current. In the standard Cutting and Washington  $\frac{1}{2}$  KW commercial set, using two gaps, or the 2 KW using four gaps of .002 of an inch each and a 500 cycle feed current with a primary condenser of the value of 0.16 mf at 600 meters, there are approximately 10,000 sparks per second or 10 per half cycle.

Having spent five years in developing, designing and marketing the type of apparatus under discussion and knowing quantitatively with the aid of the Braun tube and Dudell oscillographs at all times just what is occurring I feel justified in warning experimenters not to try impulse excitation with unsuitable apparatus as the results are bound to be extremely disappointing.

Yours very truly,

Bowden Washington.  
Chief Engineer.

BW-R.

### ON BREAKING INTO THIS HORRIBLE GAME.

95 Grand St.  
Garfield, N. J.

Editor, QST.

Dear Sir:

Replying to Bugs' letter in November QST wherein he advocates that amateur beginners buy their first sets rather than make them, and that an audion be preferred to a crystal detector set, etc.

Where does he get his courage to disseminate this misinformation? Who ever heard of an amateur starting his set with an audion?

He says "how about the little fellow who hardly knows what size wire to use." Very true, and what's more, most of them have only a faint idea of the rectification of radio frequency waves into audible sibs by crystal detector. That being the case, what does he know about grid condenser

hook ups, plate voltages, filament rheos, etc. To the average beginner the criss-cross entrails of a loose coupler are a mystery, and he can learn more about the internal workings of all his apparatus by making it himself and seeing it work, than he can learn from a whole library of books.

O.M. Bugs' dope is wrong. According to him an amateur should first get a 1 K.W. Tfmr., O.T., and all the other gadgets that go with it, and afterwards think of experimenting with spark coils.

Start at the bottom. Algebra isn't taught in the Kindergarten. Get your audion after you have digested all the dope on "galena detectors and bum fixed condensers", and you will have no regrets; and after getting the audion and hooking up various Micro-farads and meg-ohm resistances up to the grid, the birdie refuses to sing, you can still hear the sigs come in on bent hair pin and good old iron pyrites.

Respectfully,  
John Stofan.

#### WHO CAN RAISE HIM ONE?

12 Oakley St., Dorchester, Mass.  
October 13, 1919.

Editor, QST:

Here is a long distance receiving record, made with home-made apparatus, which I should like to hang up for the boys to shoot at.

While listening in on 600 meters I heard the British land station at Demerara, British Guiana, roughly about 2700 miles south, and upon tuning him in to his full strength was able to read the signals with my phones about eight inches from my ear. The call letters of the station are BZL. While listening to him Cape May and Cleveland, NSD and NNH respectively, started up but I was able to read BZL through them with ease owing to the sharpness with which my set tunes. I have heard BZL several times before but never so loud. He works frequently with VPL at Trinidad.

Truly yours,  
E. A. Gisburne  
One Dee Eye.

P. S. I fear we shall need the Woof Houg in this vicinity soon, so preserve the wrapping the OLD MAN put arnd it.

#### ANOTHER AMPLIFYING HOOKUP.

546 Kitchener Ave.,  
Detroit, Mich. October 21/19.

The Editor, QST:

I note in the October number of your periodical on page 27 a hook-up by Lt. Klaus of what he terms an oscillating-amplifying-detector circuit.

I have tried out the hook-up described by Lt. Kraus, and while it has several merits, I believe the hook-up herein attach-

ed which I "discovered" a few months ago will amplify signals to a greater degree and with proper adjusting of condensers C-3 and C-4 will oscillate at any wave length. This circuit, as well as the one described by Lt. Klaus, amplifies spark signals without changing the note when the detector (or the condenser C-3) is adjusted just below the oscillating period.

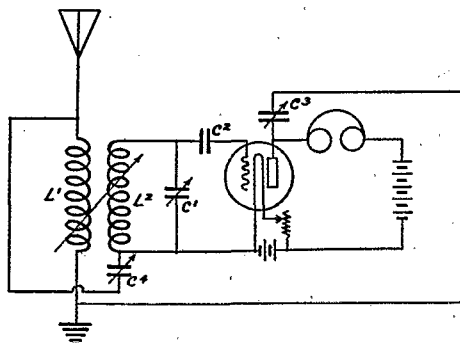

I have used a one-tenth MF condenser in place of the variable at C-4 with practically no change in tuning. Condenser C-3 is preferably one of .001 MF or larger. The rest of the circuit is standard.

I might add this circuit has the same peculiarities as the hook-up described by Lt. Klaus, in regard to tuning; and from the standpoint of efficiency—ease of operation and simplicity—I am convinced it will be of interest to your readers.

Respectfully yours,  
Herbert V. Simmons

#### DELCO AMPLIFICATION.

Dr. L. G. VanSlyke, of Hyattsville, Wyo., in a recent letter tells of interesting observations in experiments where his filament circuit seems to act as his antenna. He says:

"I have discovered that in using my 32-volt house lighting system to light my filament, cut down thru a home-made rheostat, an amplification of signals several hundred times is caused. In fact, when there is static I cut out my aerial and can copy all the following stations very clearly: NPG, NPZ, NPL, NPM, NWO, NAT, NAA, NWW, NDD, NSS, and several long wave spark sets come in with remarkable clearness. This I could never do before while using a separate battery, and about all the stations I ever heard without an aerial was NPL and now and then NWW, but now they all come in in a bunch and the primary of my tuner might as well be in the fire as it's of no use under these conditions. When using my aerial I get NPM nearly as loud as NPG, and NAA spark set comes in at noon like a whirl-

wind. Do you happen to know if this scheme was ever tried before?"

Have any other of our readers noticed similar effects?

### WHY IS AN AMATEUR?

Denver, Colo., Oct. 22, 1919.

Editor QST:—

Herewith enclosed is a suggestion on which I would like to hear the opinions of others in your magazine.

Ever since the earliest days of wireless, the many men and boys who have undertaken to build their own sets or to operate any set, whether for pleasure or for experimental purposes, that did not come under the classification of Commercial or military work, have been termed "amateurs".

In all other lines of work, "amateur" means one who is either learning or is not proficient in his work. Now can the people that are daily experimenting and operating their own sets be rightfully called amateurs? Hundreds of men and boys have sets that commercial companies might envy. Again, hundreds more can operate their sets every bit as efficient as the man in the land stations, ship stations, in the military and Naval Forces of the world, men who are termed "Radio Operators"; in fact many commercial operators could well take lessons from some of our leading amateurs in operation of radio sets.

Really now, are these so called amateurs, amateurs in the true sense of the word?

An average outsider hearing the word "amateur" applied to somebody in the wireless game, naturally concludes that this person is a beginner, and looks upon him as a "nut".

Many unknowing land wire telegraphers, hearing the word "amateur" applied to men connected with wireless, regard him as a "ham" or "lid".

"Ham"! Possibly, but not probably. Men who can show many of them up when it comes to receiving signals through static and other interference which corresponds to working a "bad wire" in land telegraphy. Men who can send signals twice as clear and readable as some of the land operators can send their Morse. Men who understand the technicality of wireless and the working of their sets and the subject of wireless in general. Whereas, nine out of every ten land wire telegraphers in this country do not even know the fundamentals and working of a simple duplex set, or a single wire repeater. Yet these wireless men are termed "amateurs" because they operate their own stations, and therefore the land wire man has a right to think this radio man is a "ham".

I am speaking of the more advanced men in the game; men who have studied the subject thoroughly and are experienced in

the operation of their sets; not necessarily the eleven year old boy who has just taken it up and has a set consisting of a tuning coil, mineral detector and an old telephone receiver. These boys are true amateurs of course, but with an average amount of study and experimenting will soon get out of that class.

Many men, previously Naval and Military wireless men, are coming back from the war and are putting up their own stations for experimental purposes and for pleasure. Are these men who have worked in some of the complex radio stations of the world to be called "amateurs"?

I, for one, favor the abolition of the word "amateur" used in connection with the wireless men of this country who own and operate their own sets.

What are opinions of others on the subject?

W. L. Matteson.

Multiplex Plant Dept. W. U. Tel. Co.

### A REFORMED SQUEAK-BOX SET

997 Sterling Place  
Brooklyn, N. Y.

Oct. 4, 1919.

QST, Dear Sirs:

In your September number, page 13, you seem to be searching for a real law-abiding, non-nuisance spark-coil transmitter.

About four years ago I started experiments with our general nuisance, to bring him into the field of practicability and respect and I think I have succeeded fairly well.

As diagrams are the shortest and best way to describe, I submit one of the set, from source of supply to the antenna.

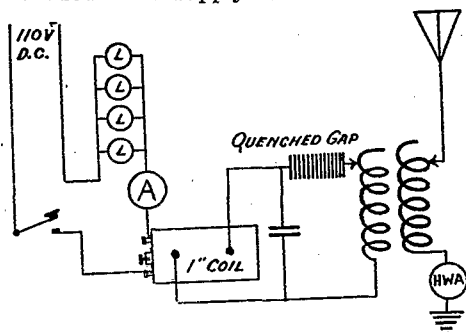

The current is 110 V.D.C. doing away with bothersome storage batteries. To cut down the amperage, 3 or more bulbs are connected in multiple-series allowing about 5 amps through; with this kick the vibrator cannot help but work. It will not stick for lack of current, for maximum is always at hand. By adjusting the thumb screw a very high pitched note can be obtained,

about 400 cycles. Now with the high frequency we can use quenched gaps, something unheard of with spark coils, but I have used them successfully for five years.

Five gaps with a sparking surface of one inch are placed in series with the oscillation transformer, which is made of brass ribbon, about 30 feet wound spirally. The primary and secondary of oscillation transformers are the same dimensions.

The condenser consists of 4 glass plates 4" x 4 3/4", tin foil in between,

The antenna is regulation for 200 meters.

With this set I have done some very efficient work and it takes the spark coil out of the nuisance class and makes a practical piece of apparatus of it.

I hope the above will be of some use to those who are just starting in. It is worth trying. You will have better luck if you do, and with a set tuned like this you will not have the inspectors after you, for you will be tuned pretty sharp.

H. B. Pearson.

#### FAN US!

Eureka, Illinois,  
Oct. 20, 1919.

Editor, QST:

Have any amateurs tried carbon grounds on their radio outfits. Altho it is not as good a conductor as copper, it has the advantage of not corroding and more surface can be exposed to the ground to make up for the lower conductivity. We are going to try one on our station and should be glad to hear from any one who may have tried this.

Yours,  
Henry Klaus.

#### MORE HI-LOW TALK

Ann Arbor, Mich.  
Oct. 16, 1919.

Dear Editor:

Today in glancing over the October issue I ran across a communication by Mr. E. E. House of Battle Creek regarding the old squabble of high note vs. low and thereupon felt inspired to put in a word.

My experience has been exactly the opposite of that of Mr. House. During the winter of 1916 and '17 I used one of those old buzz-saw types originated by 9ZN, and the spark it gave, when mounted on an induction motor, approximated 465 in frequency. With a 3/4 KW Thordarson giving a voltage of 10,000 and on a wave slightly over 200, if my wave meter told the truth, I managed to push thru to 2AGJ and 5DU pretty consistently. Also, whenever I could catch the ear of 9ZF I had little trouble in working steadily. 9ZN

was using the same type gap and you might ask 2AGJ, 2ZL and a few of those fellows how we came in.

I merely mentioned this as one example of good work done by the low note, for I firmly believe, with you, that the design of the rest of the set is the whole secret.

I too found it of considerable advantage to put my transformer on the floor to get it away from the rest of the set. Moreover, I bought myself a 5-gal. earthen jar and put the transformer in that and, filling it with oil, found my transformer troubles to have all vanished and my radiation to have been somewhat increased.

Ex-8XA has an application now in for a license and, as soon as it arrives, I am in hopes of getting a chance to sit in occasionally.

Sincerely yours,  
L. Armstrong Kern.

#### AN INTERESTING HOOKUP.

Washington, D. C.

Editor QST:

I am sending you a hookup that I happened onto accidentally, and it gives excellent results as a regenerative hookup and also is a very good one for the reception of undamped waves. The condenser used is a regular stock Murdock .001 MF type and the regular grid condenser is a very small one using mica as the dielectric,

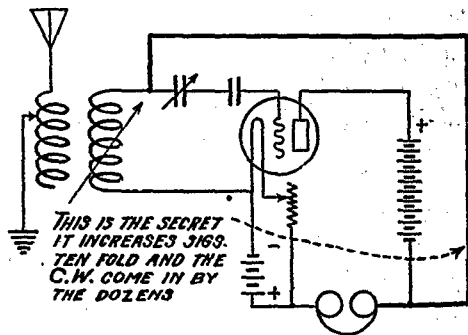

three pieces one half inch wide and about .025 inch thick with the sheets of copper about three eighths wide, and four of them are used. This hookup will amplify the signals ten fold. If you think it is of any use to the rest of the bugs, why go to it and do your worst. Best Wishes.

Yours truly,  
A. B. Brown.

(Mr. Brown has rediscovered, in essence, the famous QST regenerative circuit—so of course it works.—Ed.)



# The Operating Department

J. O. Smith, Traffic Manager  
Rockville Centre, L. I.

**A**LTHO taking off rather slowly, amateur relaying is rapidly gaining momentum and already some of the routes are open to traffic. Some of our mid-western stations are working the Atlantic Coast with ridiculous ease, and the gain to amateur operating thru the war-time perfection of equipment—particularly amplifiers—is very forcibly brot home to one. Broadly speaking, at this writing traffic is open from New York to Topeka, Kansas, and intermediate points, and from Duluth to Little Rock. This is possible on account of the exceptional work of a few good stations who got going early, and is not evidence of the perfection of the A.R.R.L. routes of short-jump stations. However, these lines are assuming shape in a very satisfactory manner and the progress henceforth will be even more rapid, so that as soon as the tentative appointees can be given a work-out and good stations substituted for weak links we can expect to get down to an uninterrupted thru service.

The Traffic Manager and the Secretary desire to call the attention of all prospective relayers to the fact that appointments on trunk lines cannot be given non-members, and so far as possible all League traffic will at all times be routed via membership-stations. We need your help, however, and you need the benefits of our organization. It is therefore of importance that you lose no time in renewing your membership in the A.R.R.L. so as to be eligible in A.R.R.L. relaying.

## ATLANTIC DIVISION.

Chas. A. Service, Jr., Manager.  
Bala, Pa.

No report has been received from Mr. Stewart, Assistant Division Manager for the Pennsylvania Section of the Atlantic Division, and therefore the Division Manager is unable to give any detailed account of this section other than that which has come to his notice through working his own radio station.

Mr. Entwistle, of the New England Section, reports that things are beginning to hum and with the assignment of new amateur call letters, the relay lines are beginning to take shape. However, it will be seen from his report that no definite routes are as yet in operation and it

therefore should make those new stations, who want to get in the relay work and who have not been assigned a place, get busy and show they are capable of handling the work. There is still room to get placed and it's up to each individual station to jump in and show results. The latter class will be those definitely slated for the Trunk Lines.

There is a suggestion contained in Mr. Entwistle's report, coming from one of his District Superintendents, which demands attention. When relay work begins to assume definite form and messages begin to cross country every night, what form of preamble or identification are we going to use for them? Of course, there is the cut and dried commercial form, which has served us in the past, but has it always been just what we need? Many are familiar with the Navy time group and how it is worked, and from these should come valuable suggestions as to its practicability in amateur work. It is certainly a more certain way of identifying a message, both as to time of filing and date thereof and message number, but whether the amateurs will take to it is yet to be settled. It is a question of the greatest good for the most number. You ex-gobs get busy and express some opinion whether you'd like it.

Also comes the suggestion from Canada, that as long as Canadian and US amateurs have similar District calls, the best way to avoid confusion is for the Canadians to use "v" instead of "de" between them, in the approved British style and Inter-allied Procedure. Maybe we'll come to the long distance amateur conditions where some of our friends across the water will be using "da" also.

This a matter for the Canadians to settle among themselves, whether they shall adopt the British system of separation of call letters, but it seems full of merit and we hope they will follow it up.

New York, Connecticut and New Jersey are coming along under Mr. McIntire and his Superintendents but they may have struck the same condition of not having received any assignment of radio calls yet, which seems to account for the slow start of relay work. The Division Manager has spent many late nights the last month over a two step amplifier trying to hear long distance, no matter how faint but nothing

stirring. Nor was it the fault of the ground, aerial or set, for local stations came in many times louder than in the old days and none of the other Philadelphia stations with good equipment could hear anything outside a thirty or forty mile radius.

Just within the last week, we hear that New York and New Jersey are coming thru, which is decidedly good news. To the South of Penna. things seem quiet. Up to the present, few if any amateur call letters have been assigned in the Third District, and we are beginning to wonder what is the matter with the radio inspector.

In conclusion, let all relay stations remember that now is the time to buck up and get things going. Don't wait for the other fellow to get his set up and call you over a few hundred miles; get on yourself after 11 PM and call your head off once in awhile and you will connect up sooner than you expect—and there will be another link in the relay chain forged.

Back issues of "QST" contain names and addresses of District Superintendents and Division Manager's Assistants, so write them and state who you are and what you are and why, and what you want to be, and they will do the rest. We want you and need you. Answer up and don't let us have to drag you out.

#### ATLANTIC DIVISION.

(Central Section)

**M. A. McIntire, Asst. Division Manager,  
1127 Ave. G, Brooklyn, N. Y.**

Due to the fact that the writer has been away on business for some little time, he has not been able to keep in touch with Radio matters in this District during the past month or so. However, things are now booming and we expect wonderful results in the near future.

At last the good word was received to again open our transmitting sets, and we have all started out strong. Real work is before us now, and we must go to it.

New stations are springing up everywhere, and it is difficult to find out just where and who they are. Therefore, we are going to look to QST each month for calls and locations. In order to get them in QST it is necessary that the owners of stations send to their District Superintendents or the writer their new call letters, or what they are signing temporarily, together with their location and transmitting power. It is requested that each station in this District do this at once, in order that Trunk Lines throughout our District can be established.

Affiliation of the Radio Traffic Association of Brooklyn has recently been accomplished with the view of their handling most of the traffic work in Brooklyn. They have about 20 members, all having first

class stations, and it is expected that they will be of great help to the League.

It is requested that the following change in addresses of District Superintendents be noted: John DiBlasi, Dist. Supt. N. Y. City, 227 East 75th Street, instead of 153 E 86th St. NYC. L. Spangenberg, 25 So. 4th Street, Lake View Heights, Paterson, N. J. Address all communications for District Superintendent of Brooklyn and Staten Island to Clifford J. Goette, 1624 Hamilton Avenue, Woodhaven, L. I.

Mr. Clifford J. Goette, District Superintendent for Brooklyn and Staten Island will temporarily handle the work of Long Island in the absence of Mr. Stanley, who is at present in South America. All stations in Long Island are requested to get in touch with Mr. Goette as soon as possible in order that we know where and who they are.

Mr. Runyon reports that Ossining, N. Y. is now open for traffic with a good station in that city. He also reports that things are going very slowly in his District, and he wishes that all those interested and having stations in his District report to him at once.

It is hoped that by the next issue of QST that a list of Trunk Lines throughout this District will be available, but due to the fact that owners of stations have been slow in responding to the request of District Superintendents this may not be available. It is earnestly requested that all stations in the States of New York, New Jersey and Connecticut who wish to be put on a Trunk Line for efficient relay work, communicate with either one of the District Superintendents as published in recent list of QST, or the writer, in order that we can establish said Trunk Lines without further delay.

#### ATLANTIC DIVISION

(New England Section)

**Guy R. Entwistle, Asst. Division Manager  
136 Sutherland Road, Brookline, Mass.**

By the time this report gets into print we will have been open two months. It is reported that there is not as much amateur activity as was expected upon the lifting of the ban, which is probably due to the expiration of all licenses during the period of the war and also to the fact that the speed has been increased to ten words per minute. Some are slow to renew their old licenses and hesitate to transmit before obtaining a new one, while others seem not to. On Oct. 10th there were only about a hundred new calls allotted at the office of the local Radio Inspector.

Mr. Bates, our District Supt. for Central Massachusetts, reports the Worcester Polytech station fast approaching an operating condition. It is planned to have

continuous service at Worcester, which is our anchor point in westward relays. Bates says he hears 1AZ going most every night, "so" we are clear in this section. Weeks, 1AG, is also heard in Worcester, and Bowen, of Fall River, comes in good. Amateurs in this section who wish to become members of a good radio club should write Mr. Bates at 8 Moen St., Worcester. Radio clubs are of much assistance in controlling QRM in their particular locality, and need your support. Get in touch with your District Supt. when you have anything to report. New prospects can get an assignment from Mr. Bates if they wish to enter the relay game.

District Supt. Harold C. Bowen, in charge of Lower Mass. and Rhode Island, suggests a new method of identifying relay messages to prevent repetition and also to assist in tracing or referring to any message at any time. Operators familiar with Naval routine will recognize its value immediately and others are requested to comment on it. He suggests that every relay MSG be followed by a group of five or six numbers, whichever the case may be. For instance, after the last word in the body of the message will appear a group of numbers, 15506. The first two will have reference to the hour of the day, beginning at midnight. 15 would therefore mean the 15th hour or 3 p. m. The next number refers to the minutes. An hour is divided into ten-minute periods. 5 would therefore mean 5/6th, or 50 mins. So far our 155 means 3:50 p. m. The numbers 06 refer to the day of the month, which is of course the sixth day. Therefore the whole series of numbers would be the reference number of the message and would at once tell us that it was filed at 3:50 p. m. the sixth day of the month. Three a. m. the same day would be 03006. This should appear as the last word in the message and be counted in the check as one word. Of course more than one message might be filed at 3:50 the 6th at different points in the country but if the station call letters are added the office of origin is at once certain. Please let us hear from you on this matter.

Bowen reports the entrance of Rhode Island State College, at Kingston, in relay work with call letters 1YA.

Lester Jenkins, of New Bedford, will look after traffic thru his city. Newport is fairly well covered but we would like to hear from prospects in Providence. Perhaps Mr. Watrous can help us there. Taunton and Attleboro are not yet assigned. Who will be the lucky ones here? ISS comes in good in Fall River. QRU?

Mr. Pulley, our greater Boston Relay Supt., says he hears the following at his station: 1BO, 1BW, 1BG, 1AU, 1DR, 1DL. He has started test messages to Mr. Smith,

Mr. Service, and Mr. Maxim. Pulley's call is 1DR.

Dist. Supt. W. H. Hardy desires to hear from amateurs in Northern Mass., New Hampshire, and Maine. Mr. R. W. Pratt, Westbrook, Me., will look after traffic in his territory and has been appointed an official A. R. R. L. station. Mr. J. Dodge, of Manchester, will assist Mr. Hardy at request. Amateurs on the Boston-Portland-Rockland-Bar Harbor-Bangor-Eastport lines passing thru Mr. Hardy's territory should write him at once for appointments as official relay stations.

Mr. Donald F. Alexander of Bangor has our best wishes in his development work, which will be pioneer in nature as his district is little worked on relay matters as yet. The jump from 1BK to Houlton is about 108 miles and will have to be done on 1/2 k.w. as there is a government experimental station up there. Canadian amateurs should co-operate with the stations in Northern Maine in the collection of relay traffic. In Van Buren, Me., the most northerly town of any size, a 1/2 k.w. set is being installed and should be included in our Savannah-Bangor route. "From Tampa to Van Buren" is their slogan. Mr. Fred Blethen of Houlton, Mr. Stuart Peckham of Bangor, Mr. Chas. Piltz of Van Buren, and Mr. Alexander, of 209 Elm St., Bangor, are the workers in this section, and they want to hear from amateurs in their section, particularly Bar Harbor, Eastport, Augusta and Waterville.

Canadian activities are on the increase. Mr. Lorimer has just returned from a little scouting trip thru Nova Scotia and New Brunswick. He sends us a very valuable and helpful suggestion. Thru some oversight American and Canadian calls in the east both begin with "2"; that is, the second districts border. It has been suggested to him that the Canadian amateurs use "v" between the called and calling letters instead of "de". For instance, 2PM v 2AA means they are Canadian stations, while 2PM de 2AA would mean they were American amateurs. I think this a very good idea and the amateur radio fraternity would like to hear remarks on this scheme. C. Walter Darling, of Sydney, Cape Breton, reports very few stations around his section—a couple in Sydney and one in Yarmouth are all he is aware of. Amateurs in this district please get in touch with Mr. Darling at the Dominion Coal Co., Sydney. The University of Dalle House, in New Brunswick, should be heard from soon in connection with relay chains in north-eastern Canada.

So much for reports. In regards general instructions, let all the amateurs send out inquiries to other amateurs in their vicinity and get lined up for the big work

that is coming. Make yourselves known to others and we will soon be back on the old-time schedule. The possibilities are great. Get in line!

#### CENTRAL DIVISION

R. H. G. Mathews, Manager,  
1316 Carmen Ave., Chicago.

There has been no report for the Central Division in the past two issues of QST, partly because of a lack of material due to the failure of the District Supts. to submit their reports on time. During the last week of October, however, the relay work has commenced in real earnest, with many of our old friends back on the job. Among those who we hear nearly every night are the following—SAHL, K. A. Duerk, Defiance, Ohio.; our old friend 8NH, now signing CC; 9HN, Crowdus, of St. Louis, 9JW, Trump of Topeka, Kansas; 8XU, Cornell University; 5BV, Johnnie Clayton, Little Rock, Ark.; 8NN of Norwalk O.; 2CS of Port Richmond N. Y.; 9ST of Superior Wis.; 9OY of St. Louis and 3AN. The Division Manager has been very fortunate in again obtaining a special license, under the same call as before the war, 9ZN and traffic is now being handled by this station on wave lengths of 200 and 425 meters. Continuous watch is kept at 9ZN between the hours of 10 P. M. and 1:00 A. M., or as late as is necessary to clear the traffic. The Division Manager has been also very fortunate in getting Mr. K. E. Hassel, formerly operator at 8YI to stand watch alternate nights at 9ZN.

With the coming of cold weather, our traffic work has already become heavy, and it is therefore extremely desirable that the District Supts. rush the formation of their intra-state routes as far as possible, so as to give outlets to the smaller towns. The work of several of the Supts. along these lines deserves special mention. Among those deserving of this are Mr. Trump, Supt. of Kansas, Mr. Gjellhaug, Supt. of Northern Minnesota, Mr. Hamilton, of Southern Indiana and Mr. Burhop of Southern Wisconsin.

In order to keep in touch with the activities of the Division to better advantage, the Division Manager has eliminated the position of Section Assistant, and accordingly the work of these two officers will be performed by the Division Manager direct. All reports and letters on business pertaining to the work of the Division should therefore be addressed to the Division Manager hereafter.

Several new appointments have been made during the past month. Mr. P. S. Pfeifer, former East Section Assistant, has resigned, as has Mr. Schnell, former West Section Assistant. Mr. Schnell is now devoting his time to the Chicago organization work, as Chicago City Manager,

and deserves commendation for his excellent work in this respect.

Mr. Chas. Zeller, 9AU (new call) of Chicago has been appointed Administrative Assistant to the Division Manager, to succeed Mr. L. E. Dutton, who is now operating for the Marconi Company.

Mr. K. A. Duerk, 8AA of Defiance Ohio, has been appointed Dist. Supt. for Western Ohio, this territory including all Ohio territory west of Columbus, and Columbus. Mr. A. J. Ball, of Hubbard, Ohio, who has been doing excellent work in handling the entire state of Ohio, in the absence of an appointee for the west part, will retain control of the eastern district, consisting of all Ohio territory east of a north and south line through Columbus. Ohio amateurs are invited to communicate with these men for relay appointments in their territories.

No appointments have been made of District Supts. in the states of Illinois or Michigan, and operators capable of holding such positions are requested to communicate at once with the Division Manager.

It is the wish of the Division Manager to see as many stations as possible engaged in actual League message traffic work, and accordingly all operators who are interested in traffic work are urged to communicate at once with the Supt. of their districts for the purpose of obtaining relay station appointments. A list of the names and addresses of the Dist. Supts., in addition to those mentioned herein, will be found on page 19 of the September issue of QST. Stations desiring appointments on Trunk lines will communicate direct with the Division Manager.

Attempts are being made to run three sets of Trunk Lines through this Division, connecting with similar lines in the other divisions. Two of these routes will be east-and-west, one through the northern portion of the division and one through the southern part. The third route will be a north-and-south one, originating at Chicago and connecting with the East Gulf Division at Little Rock. To date no serious attempt has been made to form a permanent organization of these trunks, as it is desired to ascertain just which stations will be capable of handling this work. At this time the three routes line up as follows:—

Line A (New York to Seattle via Chicago)

(Central Division section)—8VP (old call) A. J. Ball, Hubbard, Ohio—8AHL (old call) K. A. Duerk, Defiance Ohio, with CC Mr. and Mrs. Chas. Candler, St. Mary's, O, as alternate—9ZN, R. H. G. Mathews, Chicago, Ill. with 9AU, Chas. Zeller, Chicago, Ill. as alternate—9ST Superior, Wis.—J. A. Gjellhaug, Baudette, Minn. (call not known)——???

Line B, (Phila. to San Francisco) has

been divided into two Branches, No. 1 and No. 2.)

Line B, Branch No. 1—8VP, Hubbard Ohio—8AHI, Defiance Ohio with CC, St. Mary's, O., as alternate—9ZN, Chicago, Ill. with 9AU, Chicago, Ill. as alternate—9JW, Topeka, Kansas—?????

Branch No. 2—8VP, Hubbard, Ohio—8AHI Defiance, Ohio with CC, St. Mary's, O. as alternate—FH, Francis Hamilton, Indianapolis, Ind.—9HN, St. Louis, Mo.—9JW, Topeka Kansas—???

Line E, (Chicago to New Orleans) 9ZN, Chicago, Ill. with 9AU, Chicago, Ill. as alternate—9HN, St. Louis, Mo. with FH, Indianapolis, Ind. as alternate—connecting with East Gulf Division at Little Rock, Ark.

The routes as outlined above are, of course, far from perfect, and will unquestionably be modified from time to time as new stations start sending. However they form a working nucleus and messages are already being handled over them, with unusual success, due no doubt to the improved quality of the apparatus in use as compared with that used before the war.

From all appearances, relay work will be done over remarkable distances with ridiculous ease, on account of the new apparatus now in use. This is especially true of such instruments as amplifiers, which are becoming ever more popular.

#### WEST GULF DIVISION,

F. M. Corlett, Division Manager,  
1101 East Eighth Street, Dallas, Texas.

The glorious news that the transmitting ban had been lifted was received with great glee throughout the division. The local newspapers were generous with their space and gave the A.R.R.L. all credit. The District Superintendents reported that the story was given wide publicity in their districts. To sum up the situation, interest has advanced several points, stations are being put in working order as fast as their owners can find the time to work on them, heavy rains interfering with outside work in Texas, applications for membership are coming in fast. The only discouraging feature at this time is our inability to get the Radio Inspector to forward necessary application blanks, this no doubt due to the sudden rush of applicants and the limited office force of the Radio Inspector, which condition I trust will be eliminated before this is in print.

District Superintendents for Oklahoma and Arizona have not been located and the Division Manager invites correspondence from members or those who desire to become members and are capable of filling these appointments.

Appointments for the month follow:—

Bennett Emerson, 3730 Wendelkin Street, Dallas, Texas, District Superintendent of Northern Texas District. Henry M. Harris, Box 427, Waco, Texas, Asst. Dist. Supt. Northern Texas Dist., assigned the TERRITORY of McClennan, Limestone, Falls, Bell, Bosque, Coryell and Lampasas Counties, the same to be known as the WACO TEXAS TERRITORY.

The dividing line separating the Northern and Southern Texas Districts is as follows:— From East to West across the state along the NORTH boundary lines of Sabine, San Augustine, Angelina, Houston, Leon, Robertson, Milam, Williamson, Burnett, San Saba, McCulloch, Concho, Sterling, Glasscock, Midland, Ector, Winkler, Loving, Reeves, Gulberson, Hudspeth and El Paso Counties.

The Ennis Texas Territory has been enlarged and now includes Ellis, Hill, Navarro, Freestone, Anderson, Henderson, Vanzandt and Kaufman Counties.

Reports of District Superintendents follow.

#### NORTHERN TEXAS DISTRICT.

Bennett Emerson, District Superintendent, 3730 Wendelkin Street, Dallas, Texas.

The date of my appointment was so close to the date of submitting report that I have not had a chance to become thoroughly acquainted with radio conditions in my district; then too, I have only recently returned here, but I am sure that it is to stay and if it ever stops raining long enough for me to persuade a couple eighty footers to stand on end I'll be on the job again at the same old stand.

The Division Manager issued a call for a local meeting of the "bunch", a few days after the ban was lifted. About twenty-five were on hand and the result was The Dallas Radio Club was organized. Kenneth Hackler was elected Secretary. The second meeting of the club was held October 24th and a motion was passed directing the Secretary to make formal application to the League for affiliation.

I want to get in touch with all station owners in Northern Texas at once; there are a number of appointments remaining to be made.

#### SOUTHERN TEXAS DISTRICT.

James L. Autry, Jr., District Supt.,  
No. 5 Courtland Place, Houston, Texas.

Everything continues very much as usual, stations gradually becoming completed and local work going on all the time, but so far there are no long distance stations in communication in the southern part of the state.

Radio Clubs are, of course due to the recent opening, going at high speed and all seem more than interested and only waiting for static to let up to go at the thing in all earnestness.

The station of the Dist. Supt. is still in course of construction but due to lack of time seems very slow. However by the time that static has let up enough for consistent work the station will be in full swing.

#### NEW MEXICO DISTRICT.

Louis Falconi, District Superintendent,  
Box 421, Roswell, New Mexico.

The Division Manager's telegram giving the glad news that the ban had been lifted was received with great joy.

The amateur radio situation down here is punk. However I believe the Asst. Div. Manager of the Pacific Division, Mr. Newnan, is going to find that someone has woke up. Some of the natives when told that there was a wireless station in town exclaimed, "Wal I swan". There were a couple of other fellows that seemed interested but they have gone off to school. The only hope at present is the college at Las Cruces which has a station. How about sending an M. D. (Radio) to inject some radio bugs into some of the folks here?

I have a short wave regenerative receiver under construction and hope to be able to handle a few in the near future.

If there are any other owners in New Mexico or any one that knows of any I want to hear from them.

#### ROCKY MOUNTAIN DIVISION.

M. S. Andelin, Manager,  
21 Northwest Temple St.,  
Salt Lake City, Utah.

Mr. R. Earl Dawes, of Bozeman, Mont., is appointed Superintendent for Montana. Amateurs in that district are requested to get in touch with him or me.

Mr. Salisbury has returned from the Navy and will be on his old job in Richfield, Utah.

Satisfactory progress is being made, and already we have a few stations on this part of Line B listening in for traffic.

#### PACIFIC DIVISION.

Seefred Brothers, Managers,  
343 So. Fremont St., Los Angeles.

Mr. H. S. Newnan, Ass't Div. Mgr. at Alameda, reports amateur radio activities are starting to liven up his way. He reports Mr. B. R. Norton, ex-6RN of 825 Fifth Street, Napa, is planning to install 1 K.W. set with a short wave audion regenerative receiver. This amateur has had experience in handling relay traffic while he was in the Navy. He ought to make a good relay station between San Francisco and Southern Oregon. Mr. Newnan reports that Mr. Noble G. Hueter, 1434 Jones Street, San Francisco, who is the first amateur to receive a post-war call, 6AA, would make a fine relay station to handle

traffic for that city; that Mr. R. C. Denny, Fresno, Calif., would make a good relay station between San Francisco and Los Angeles; and that 6AV of Reno, Nev., is now in communication with 6FT of Stanford University and 6AU of San Jose, Calif. Mr. W. R. Coover, 2919 Fifth Ave., Sacramento, Calif., ex-6UX, and another amateur 6HH, Mr. Yeaw, of that city, would make fine relay stations between Reno, Nev. and San Francisco.

Mr. O'Brien, Tacoma, Wash., Dist. Supt., reports that he has started to line up the relay stations in his district. His work in the pre-war days was Boise, Idaho, 7CE, transmitting range. He states that he has twenty-five local men lined up there and in a very short time will have them all in the League. He has formed a club (Tacoma Radio Club) and aside from this has written to forty-odd men thruout the state, and had some placards printed to bring in the boys, also using the local newspaper to boost the good work of the League. He says he has a real live-wire, Ass't Supt., Mr. Ardis Reeder, 412 So. K Street, who will take charge of the club work and allow him to devote more time to the state work. He says he has gotten in touch with Mr. Cameron at Portland to help him get the trunk line completed thru Washington. He expects to run tests with him within a week or ten days, and later on straight thru to us.

In Los Angeles and Southern California things are coming along slowly on account of the delay in issuing licenses to the amateurs. Amateurs who wish to handle relay traffic for the suburban towns are Mr. F. G. Beck, 417 C Street, Wilmington, Calif., ex-8KF of Greensburg, Pa.; Mr. Chas. Hibbard, 156 Bellefontaine St., Pasadena, ex-6DC; Mr. Wm. Holladay, 301 So. Fir Street, Inglewood; Mr. Arno A. Kluge, 638 So. Figueroa St., ex-9YJ of Lincoln, Nebr.; Mr. H. StJ. McIntosh, 322 East Cypress Ave., Glendale, ex-6HJ; Mr. Stanley Whitehead, 138 No. Bixel St., ex-6CX; Mr. Robert Downs, 3938 1/2 So. Grand Ave., ex-6RG of San Diego; Mr. Dick Lee, 2626 San Fernando Ave., ex-6LG; Mr. Oliver Garretson, 2817 So. La Salle Ave., ex-6QU; Mr. Arthur Munzig, Redlands; Mr. Harold Squires, Corona, ex-6ABK; Mr. Summers and Mr. Watkins, University of So. California, new call 6YA; Seefred Bros., 343 So. Fremont Ave., ex-6EA.

We expect to run tests within a couple of weeks to determine what relay stations are the best suited on the trunk lines.

Mr. Terman, Supt. of the San Francisco District, reports satisfactory progress in the shaping up of things, but that traffic has not yet started. The present line-up of stations is as follows: Reno, ex-6AV; San Jose, ex-6AAC; ex-6AU; Palo Alto;

ex-6FT, ex-6AG, ex-6FK; San Francisco, ex-6SH, 6AA; Oakland, Alameda, ex-6AHN; Monterey, ex-6GC; Walnut Grove, ex-6KU; Lodi, JS. 6AA, ex-stations 6FT, 6ACC, 6AU and 6AV are working at present, and satisfactory communication was established between 6AV and 6FT on Oct. 17th, leaving the next step to make connections with Los Angeles.

Mr. L. L. Hoyt, Dist. Supt. for Northern Washington, reports about thirty amateur licenses issued in the 7th district up to the date of his report, the names appearing in QST's Directory of Calls. Only a few of these have been heard to date. Those with equipment in operating condition are: 7AK, 7AH, 7AD, 7AB, 7AC, 7AA, 7AG, 7AU, 7AQ. Mr. Hoyt wishes to express his appreciation to Mr. Peter Veit, Seattle, for his cordial help in getting operators lined up for the A.R.R.L.

#### EAST GULF DIVISION.

John C. Cooper, Jr., Manager.  
Atlantic National Bank Building  
Jacksonville, Florida.

Although transmitting has been authorized for a full month, there has not been very much progress made in this division; not many licenses have been issued, and weather conditions have been bad. However, a great deal of work is being done by the District Superintendents and Assistant Division Managers, and a successful season should be the result. The present organization is as follows:

**CAROLINA SECTION:** No appointments.

**EASTERN SECTION:** Assistant Division Manager: W. B. Pope, No. 197 Dearing Avenue, Athens, Georgia. District Superintendent for Georgia: Mr. Philip E. Bangs, 29 Albemarle Avenue, Atlanta, Ga. For South Florida: Mr. Houston Wall, Tampa, Florida;

**WESTERN SECTION:** Assistant Division Manager: Mr. John M. Clayton, 1301 Welch St., Little Rock, Arkansas. District Superintendents for Louisiana: P. E. Greenlaw, Franklinton, La., D. R. Simmons, Shreveport, La.

The only radio club that seems to be fully organized in this division is the Atlanta Radio Club, of which Mr. Bangs, District Superintendent for Georgia, is president.

**CAROLINA SECTION:** Amateurs in this section are again urged to communicate with the Division Manager.

**EASTERN SECTION:** Mr. Pope reports that weather conditions have been very unfavorable and that there seems to be considerable lack of interest in some of the stations on which he had relied.

However, several new stations look promising. We have considerable hope in the future of the station at the Georgia Institute of Technology at Atlanta under the general supervision of Mr. Bangs, who is District Superintendent. The station has been placed in charge of Pinkston, of Valdosta, and Whitaker and Flowers, of Atlanta. These very capable men should make it one of the best stations in the South, as we understand they have the full backing of the college authorities.

Mr. V. C. Melvaine, formerly of Tampa, Florida, is now connected with the Alabama Polytechnic Institute, at Auburn, Ala., and hopes to be able to establish a good station to be used for relay purposes.

Mr. Wall, district superintendent for Southern Florida is also in communication with some of the colleges in Florida with the hope of having stations established.

**WESTERN SECTION:** Mr. Clayton reports that the stations of Mr. Vance Thompson, of Nashville, Tennessee, and Mr. J. C. Shannon of Meridian, Miss., have been appointed official relay stations at the points named.

Mr. Clayton is working actively to get the relay lines in shape throughout his territory, but is greatly handicapped by bad weather conditions. He is showing great energy in handling the situation and as soon as more stations are opened and weather conditions improve, his section will be in fine shape to handle all necessary work.

#### ON HANDLING TRAFFIC.

(Concluded from page 18)

It is quite useless to forward the filing hour. If the place of origin is placed between the number and filing date a confusing sequence of figures will be avoided. In handling traffic avoid the use of code abbreviations and cultivate the art of spacing letters and words. Repeat peculiar words and avoid anything which might confuse the receiving operator.

Traffic should in all cases be handled in short jumps. The intervals should be short enough to insure reliable and easy communication during daylight. The League offers a real service, and the object of every league operator should be to keep his traffic hook clear. Use SVC messages for long distance tests. Furthermore, straining transformers and gaps to the limit only results in fading signals, which are more difficult to copy than any other.

There is such a thing as taking all the joy out of life by making rules about everything but there are certain common-sense rules which if applied to A.R.R.L. work will add to the pleasure which is derived from it.

# THE JUNIOR OPERATOR

Conducted by Guy R. Entwistle

QST is fortunate in having secured the assistance of Mr. Entwistle in the handling of this Department. Mr. Entwistle, who by the way represents QST in Greater Boston, conducts the Saturday morning free classes for amateurs at the Massachusetts Radio & Telegraph School, and the matter presented in this Department will be based on the particular needs of the young fraternity as observed in these classes.—Editor.

**B**ELIEVING that there is a keen need on the part of the beginner for instructive but non-technical articles on wireless, the Editor has set aside a section of QST for the purpose of helping the novice over the rough spots that always confront the amateur in his first stages of radio.

Most amateurs like articles on construction of simple but effective apparatus that can be used when it is finished. Of course a general idea of just why the apparatus is being constructed is also necessary. Radiotelegraphy will herein have the precedence over Radiotelephony, altho a few simple ideas on this subject will come later. It is believed that there is equal demand for articles on both receiving and transmitting. It is assumed that the reader is from 10 to 18 years of age and is attending school but has no working knowledge of mathematics, and hence their use in anything but A B C form will be left out. Technical terms also will not be used unless they are explained before-hand. Diagrams will be numbered serially and will be referred to from time to time in future articles, so it behooves the student to keep a complete set of QST's.

It is also assumed that the reader is somewhere along the receiving speed of from one to ten words a minute and is still in the land of spark-coils and small transformers and has his mind on the double slide tuner or loose-coupler, and for the most part uses the old reliable crystal detector.

One of the main objects of the articles is to prepare him for the amateur examination. We intend to be conservative in our ideas and not to give way to the tree or the bed-spring variety of antenna. The spark coil is not forbidden, yet the proper use of this much abused article is suggested. Determination of your sending distance will not be attempted.

Having set forth the object and the general nature of the articles to be expected it might be well to first briefly explain just what a beginner should know

of the workings of the wireless.

To the question of "How does the wireless work" there have been many different answers from the novice. He realizes there is a splash in something he calls the air, that produces waves which travel out from his antenna in all directions. It is perhaps sufficient at this early stage of the game if he learns that electricity traveling very fast up and down the antenna at the sending stations creates disturbances in this so-called "air" or ether which spread out in all directions, becoming weaker the farther they go. If course we can't see these but we can for a moment imagine ourselves sitting on a high cliff watching the waves of the ocean. (Fig. 4.) The tops of the waves are so many feet apart as they follow each other in toward the shore. This distance is called a **wave length**, a term much used in

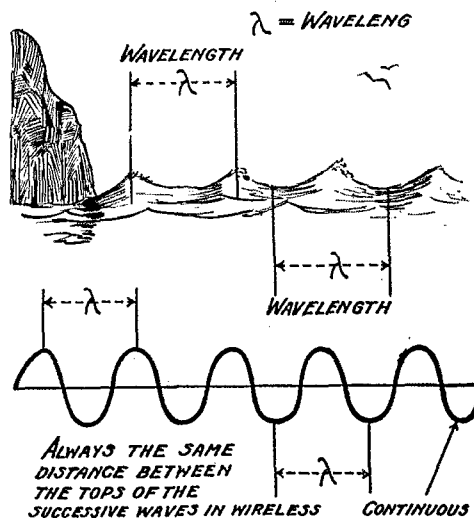

FIG. 4.

wireless. In a similar way if we could see our wireless waves, they too would be following each other so many feet apart. If there are any wires in the path of these waves as they travel outward we will also find electricity traveling up and down them also. The wind and the moon and other things govern the length of the sea waves but the length, height, and the number of wires determine the "wave length" of the waves sent out by our antenna. It is also found that when the wave length of the antenna of our receiving station is the same as that at



the transmitting station we get the most electricity "induced" in the antenna of the former.

In our imaginary case we had the electricity running up and down one antenna at a rapid rate and we obtained some of this electricity at our receiving station. Such we called a simple wireless set. There were no wires connecting the two points altho we might have used much wire at either of the two stations to produce these results.

But what will make electricity travel up and down our antenna at this rapid rate that is necessary before the waves will be sent out? It has been found that the discharge of a condenser will produce these quick surges of electricity, first in one direction and then in the other. When a current surges back and forth like this we call it an oscillatory current. Such a current is necessary to produce wireless waves.

We have learned so far that WIRELESS WAVES ARE PRODUCED IN THE ETHER WHEN AN OSCILLATORY CURRENT SURGES UP AND DOWN OUR SENDING ANTENNA, AND THAT WE WILL GET THE MOST ELECTRICITY ABSORBED BY OUR RECEIVING STATION WHEN THE WAVE LENGTHS OF THE TWO STATIONS ARE THE SAME. THAT IS, WHEN OUR RECEIVING ANTENNA IS ADJUSTED SO AS TO RECEIVE WAVES OF THE SAME LENGTH AS THOSE COMING FROM OUR TRANSMITTER ONLY.

The beginner may well ask now, "Well, what is a condenser?" A condenser is a piece of electrical apparatus that will store up stationary electricity. A reservoir so to speak. It consists of two conductors of electricity separated by something that will not conduct electricity. Tinfoil and glass plates make a good condenser for the beginner to construct, for sending.

However we are not yet ready to go into the construction of any apparatus until we finish our little introduction, giving a general idea of wireless. Remember you can't learn radio in a day. Regular and proper study is necessary. Hence be faithful with your first lesson and we will assure you results in the future.

Before this condenser can be discharged to produce ether waves it must first be CHARGED. A condenser can be charged by any source of high voltage such as that given off by a spark coil secondary or a

step-up transformer. We will not go any further back than this at present with transmitting but will turn our attention to the electricity present in our receiving antenna after we have adjusted both to the same wave length, or "tuned" them. After we collect this electricity we must have some means of determining its presence. This is done conjointly by a detector and a pair of telephones. A detector usually consists of a piece of crystal and a metallic point, the latter resting on top of the surface of the former. It is believed that the beginner is not capable in

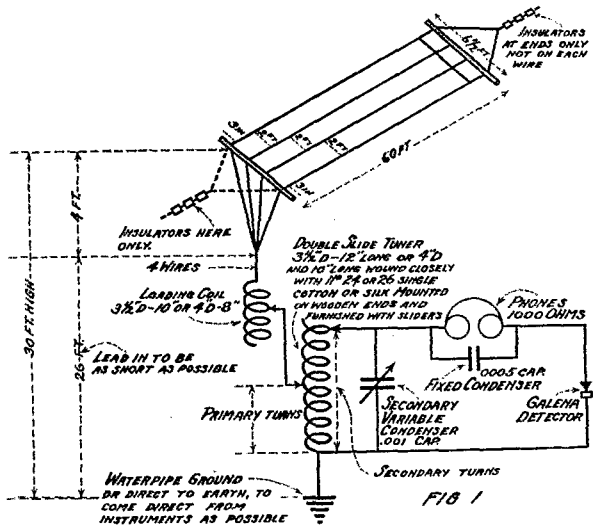

the first lesson of properly understanding the workings of a detector but it will be sufficient to say that the electricity received at our receiving station is in such a form to be useless to us unless it is changed in its nature. Hence the purpose of the detector is to convert the electricity we pick up into a usable form that will be recorded in the telephones, as a buzz. Thus it is seen that the simplest form of a wireless set has for a transmitter some producer of oscillations, usually the discharge of a condenser, and at the receiving station something to absorb the waves which result from these oscillations together with proper instruments to convert the electricity into a state where it can be used and some means of hearing it after it has been converted.

Now that we have briefly explained what takes place when a wireless is sent from one station to another we will proceed to a more interesting side of the subject, especially from the standpoint of the beginner. A beginner wants to know just what apparatus is necessary; first, to receive short wave stations, 200 meters to 1000

for general work, and also to be able to "get Arlington", which sends on 2500 meters. This is the upper limit on sparks for most of us.

It is believed that since Arlington sends probably around 15 to 18 words per min. the beginners will be better off if they don't try for NAA just yet and confine themselves to that band of waves from 200 to 1000 meters. Just a word about the term "meters". In this country when we wish to measure the distance between two points we say it is so many FEET. In foreign countries, where wireless originated, they spoke of two objects as being so many meters apart, hence in referring to the length of the emitted wireless waves it has been passed down to us in "meters." A meter is about  $3\frac{1}{4}$  feet, so when we say a station is sending on a wave of 200 meters we might just as well say it is sending on a wave of 200m. X  $3\frac{1}{4}$  or 650 feet. In other words if we could see the waves as they are sent from our antenna they would follow each other 650 feet apart.

Our receiving set should consist of

- (1) An antenna
- (2) Double slide tuner or loose coupler.
- (3) Detector
- (4) Phones
- (5) A small fixed telephone condenser.

The next problem is what is the best kind of an antenna to put up and how long and how high should it be and how many wires and what is the best spacing.

The antenna we suggest for receiving is one that can also be used for sending when we get around to it, as few of us can erect two separate antennae at our station. The law says we shall not send out a wave that is over 650 feet long (200 meters). At this point let us try to form some idea of the relation between the dimensions of our antenna and the length of wave that is sent out from it. There is a well known relation between the straight vertical wire suspended in the air and grounded at one end; that is, one end connected to the earth (water pipe; don't use the gas pipe; it's a bad habit when you come to transmitting, as you may some day be separated from this course) which gives us waves that follow each other at a distance apart of 4 times the vertical height of the single wire. Therefore if we wish our emitted wave to be 650 feet (or 200 meters) we would divide 650 feet by 4 and get 162 feet as the height of our vertical wire.

However this type of antenna is not recommended for several reasons and was merely mentioned to show the relation between wave length and length of antenna. A more common type is the "T" and "L" type, the latter being seen on

most ships. This is not a paper on antennae so we will have to let the advantages and disadvantages of each type go until later.

We would suggest an antennae of the following proportions:

Height, 40 ft.; length, 50 ft.

or

Height, 30 ft.; length, 60 ft.

Note total length in each case is about 90 feet. 4 wires spaced 2 feet apart. (Fig. 4.)

The size of wire is not important for the beginner but regular antenna wire is recommended and #14 bare copper will do. The natural period or natural wave sent out by this size antenna without any loading coils in series will be approximately 160 meters. You will notice we have left

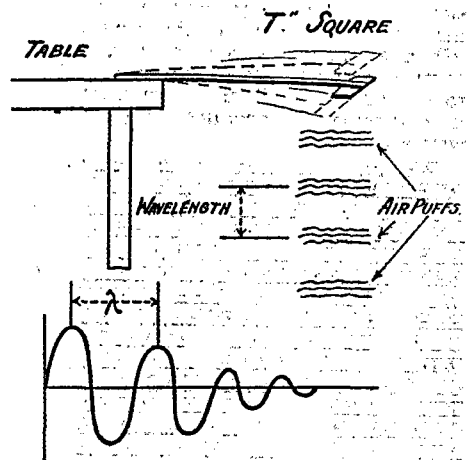

FIG. 5.

40 meters, out of our 200 meters, for use with loading coil or the primary winding of our loose coupler or the primary of the double slider as the case may be. If we had made the antenna longer and obtained 200 meters from it alone without allowing for any additional coils in series we would be above 200 meters when we came to hook up our set. While this would not make any difference in the case of a receiving antenna, as we have other means to reduce its wave length if it is too long, in the case of transmitting we must be careful of this point, and provide a place for the remainder of our apparatus so we can still be within the law.

Just a word about what is meant by the natural wave of an antenna. Take a "T-square" and hold one end securely on the edge of a table. (Fig. 5.) Suppose you have held the end where the "T" is. Now still holding this end firmly raise the other end which is probably 2 or 3 feet away and let go. Notice the vibrations of the thin springy wood.

Repeat and get a mental picture of how fast it is vibrating. Now turn the "T" square end for end and do the same thing. Notice in this case the whole thing is vibrating slower than before. Suppose further that in each case as the wide strip of wood swung down it sent a puff of air ahead of it; then these puffs would follow each other at regular intervals and the distance between the successive puffs we will call a wave length. In the first case the strip of wood was vibrating in its own natural period or natural wave length. It was vibrating naturally. In the second case the heavy strip of wood that forms the "T" acted as a weight on the long slender strip and tended to slow it down or make it vibrate more slowly.

Reflect a moment and notice that the slower vibrations produce the longest intervals between the successive puffs and since the distance between any two of these puffs is called a wave length then our wave length in the second case is longer than in the first case when the stick vibrated faster. The stick can be said to have been "loaded".

We have been dealing with a system of mechanical vibration.

Now in the same way our antenna is set into vibration by oscillating currents surging up and down it. Of course there is no motion of the antenna but waves of certain lengths are sent out from it. We are not ready as yet to go into this subject of waves any more than to try to furnish some foundation upon which to build our elementary ideas on wireless. It would be well if the beginner learn the relation between the wave sent out and the speed of vibration of a body. **REMEMBER, THE FASTER THE VIBRATION THE SHORTER THE WAVE LENGTH SENT OUT.** We will refer to this later on in these articles. So much for our antenna behavior.

The double slide tuner can be bought cheaply or wound by the amateur himself. The tube already wound with bare wire and other necessary parts such as ends and slides and rods can be picked up at the local radio supply houses probably as cheap in the long run as the beginner can do by constructing them himself. However, the amateur is encouraged to make all the apparatus he can at first so as to gain the experience. Get in touch with the older fellows; perhaps they have some apparatus to sell cheap or even give away.

The object of the tuning coil, whether it be a single slide, double slide or loose coupler, is to permit the reception of many different wave lengths at different times, as we wish within the limits of the apparatus. If we wished to receive from one station always, and always on the same

wave length, all we would need would be an antenna, a detector and a pair of phones. No tuning would be necessary, as we would make the antenna wave length the same as that of the incoming signal wave and we would always be in "tune". Naturally this would be a crude outfit but it illustrates an important principle. A tuning coil allows us to add to the length of the wire in our antenna, not on the roof, but in the wireless room. Thus we can get waves as long as the wave of our aerial or longer by the use of the tuner. Again notice also that if we coil up two or three hundred feet of wire the electrical effect or electrical length is much greater than two or three hundred feet stretched out as one wire. In other words we can do as much with say 200 feet of wire coiled up as we could do with say 600 feet added directly to the antenna length on the roof. Again remember that the wave length of the receiving station at any particular time depends upon wherever we happen to leave the sliders or condensers when we last used the set.

At this point it might be well to illustrate what is meant in wireless when we speak of two circuits being in "resonance", a condition and understanding of which the beginner must grasp before he advances in his study of wireless. If we place a plain spark gap across the secondary or high voltage side of our spark coil or transformer, and connect our antenna lead-in to one side of the gap and the ground to the other we will send out waves of a certain length. This is because the antenna has so much of a property called CAPACITY and so much of another property called INDUCTANCE. Certain combinations of these two properties produce waves of a certain length. **THE SAME COMBINATIONS OF CAPACITY AND INDUCTANCE WILL ALWAYS PRODUCE WAVES OF THE SAME LENGTH, NO MATTER WHERE THEY ARE IN USE.** Also the beginner should remember that these waves are the same distance apart even after the waves have traveled a thousand miles away. They may be weaker but the wave length has not changed. That is why they come in on the same place on tuners of two identical stations many miles apart. As far as the beginner is concerned, then, **THE WAVE LENGTH DEPENDS ON THE AMOUNT OF CAPACITY AND INDUCTANCE WE HAVE IN OUR CIRCUITS.**

Our antenna has so much of each and if it is not sufficient to receive a given incoming wave then we must "LOAD" it up with more condenser or more inductance. It is not possible to add capacity alone in the form of a condenser directly to our antenna so we add inductance in the form of a load coil. Some students at

this point may ask what we mean by the term inductance. It is sufficient for the beginner to understand that whenever we wind wire into a coil we create in it this property we have called Inductance. Of course a straight wire possesses the property also, but not to the same extent as when the same wire is coiled up. And it would be well also for the amateur to remember that this property we call Inductance increases, roughly speaking, as the square of the number of turns we wind on our tuners or loaders. That is if we keep the same diameter of tube and wind three times as many turns on one coil as on another we have NINE times the inductance in the case of the coil with the three times as many turns. We have previously explained capacity, but can further say it is the ability to store up electricity and depends on the area of the separated surfaces and the distance apart these surfaces are placed. Capacity increases as we increase the area of the plates and decreases as we separate them farther. The higher we put our antenna the less capacity, roughly speaking. The wider we make our spreaders the more capacity our antenna will have, and the longer the wave length it will tune to.

Now in regard to resonance. One condition we must fulfill is that PRIMARY WAVE LENGTH = SECONDARY WAVE LENGTH. But we have learned, PRIMARY WAVE DEPENDS ON PRIMARY CAPACITY AND INDUCTANCE AND FURTHER, SECONDARY WAVE LENGTH DEPENDS ON SECONDARY CAPACITY AND INDUCTANCE. Bear in mind primary capacity and secondary capacity do not have to be equal nor does there have to be any equality of inductance between the primary or secondary circuits, but THERE IS ONE RELATION THAT MUST BE KEPT CONSTANTLY IN MIND AND THAT IS THIS: IF

PRIMARY CAPACITY IS 2 UNITS AND ITS INDUCTANCE IS 12 UNITS, MAKING  $L \text{ (INDUCTANCE) } \times C \text{ (CAPACITY) } = 24 \text{ UNITS}$ , THEN IF OUR SECONDARY INDUCTANCE IS 8 UNITS OUR SECONDARY CAPACITY MUST BE EQUAL TO 3 UNITS TO GIVE US 24 UNITS IN THE SECONDARY ALSO. Go over this again and again until you thoroughly understand it, as it is one of the basic principles of wireless. Prim.  $L \times C$  must equal Sec.  $L \times C$ , where L stands for the effect produced by our turns of wire on the tuners and C stands for the antenna capacity and also the variable condenser across the secondary. If we use a variable across our primary this will also have to be included in our primary capacity and some compensation must be made in the secondary either in the form of more turns or more capacity.

One of the greatest mistakes that the beginner makes is that in trying to get Arlington he loads up his primary but fails to add anything to his secondary to INCREASE its wave also, consequently his set is not "tuned" and is "out of resonance", resulting in failure to receive what the other fellow does.

Most of the amateurs who are just starting in want hookups of doubleslide tuners and loose couplers, using both crystal (Fig. 2.) and audion detectors. (Fig. 3.) These diagrams are of the old reliable kind and we do not intend to confuse the beginner with new-fangled ideas. While the first lesson has not included any definite information on the actual construction of any particular piece of apparatus it is hoped that the amateur has learned a little more than he knew before on the why and wherefore of wireless. In later issues will appear definite descriptions of how to make your own.

(Continued next month)

## RADIO OPERATORS

\$125 PER MONTH AND UPWARD

Modern Equipment  
Individual Instruction

Special Short Course  
Finest Staff of Teachers

DORMITORY — SWIMMING POOL

Call or Write for Illustrated Booklet

### Y. M. C. A. RADIO SCHOOL

DEPT. R

153 EAST 86TH ST.

NEW YORK, N. Y.

"BEST RADIO SCHOOL IN THE EAST"



## "TEXAS LEAGUERS"

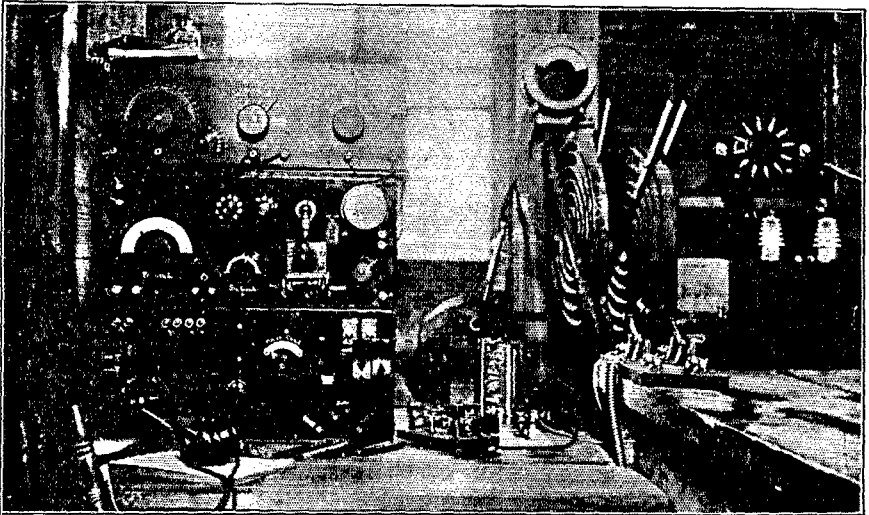

It certainly is good to have the station photos rolling in again. Here we have a pair of aces from Texas. The view above is of 5AG, the station of Mr. Donald H. Graham at Elm Grove Plantation, House, Texas. This station is now in daily operation with Houston, with 5AC generally acting as the city terminal. Most of the messages handled relate to plantation business and its owner finds it most convenient for ordering supplies, tracing shipments, obtaining market reports and weather forecasts, etc. The short wave receiver is a Paragon, and the station also has a long wave receiver using DeForest honeycomb coils in a cabinet of original design. We can't tell much about the transmitter; it looks as tho the leads were rather long. The oscillation transformer is of the hinged type, which is very convenient in locating the best value of coupling.

The two smaller views at the top of the

next page are the receiver and transmitter at 5AL, the station of Mr. Wesley Hope Tilley, at Austin. The receiving set is of original design, and while built to do its best work on short waves, with the two honeycomb coils shown to the right of the cabinet it has a working range up to 20,000 meters. The transmitter is as near perfect as is owner can get it. The "ice-box" cabinet is most convenient. Note the insulators on which it rests, and the treatment of the antenna lead. These should make for efficiency. The proposition of a separate antenna loader is one we wish were more generally followed. In the ordinary oscillation transformer, every change in the secondary in adjusting also changes the coupling, necessitating still further manipulation; but with this arrangement the mutual inductance remains constant and exact resonance is easily obtainable.

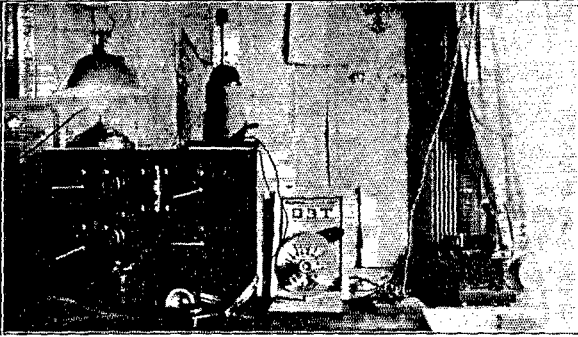

5AL's Receiver

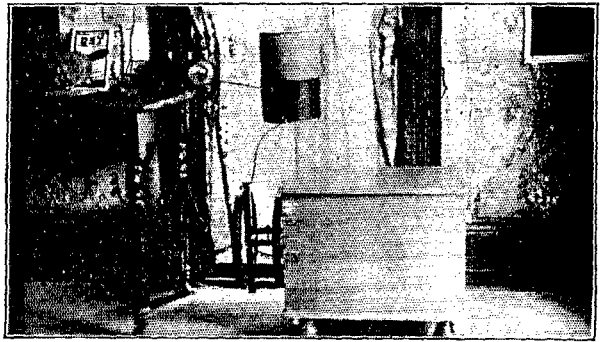

Transmitter at 5AL

## CANUCK 2AB

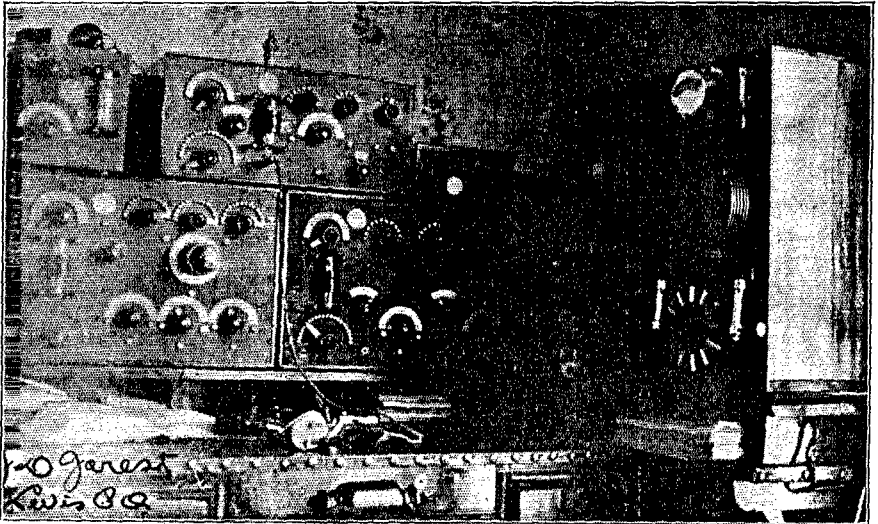

This comprehensive outfit is the station of Mr. J. D. Jarest at Levis, Quebec, Canada, about 190 miles north of St. Johnsbury, Vt. His call letters are 2AB.

We hope that with the expansion of League work into Canada, Mr. Jarest's station will get an opportunity to handle relay traffic to and from the States.



In asking questions, observe the following.

- (1) Number each question
- (2) Write on one side of paper only
- (3) State each question clearly
- (4) Be as brief as possible

No queries answered by mail.

Chas. L. Reynolds, New York:

Q. I want to be able to transfer my set from damped to undamped (three honeycomb coils) using one AudioTron. Will you please give hookup?

A. Here given.

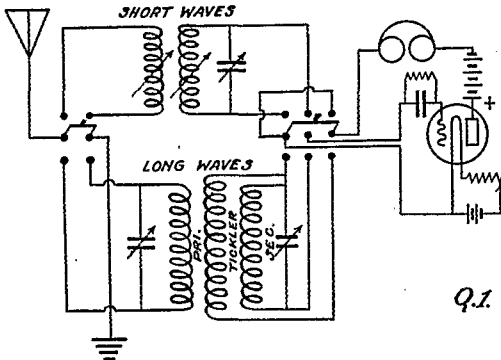

Q.1

C. L. Webber, New York:

Q. Describes at length an interesting doughnut set designed for NAA but which "won't work" and wants to know what the trouble is.

A. Set seems OK in all respects, as regards design, and because you hear a continual humming sound we feel sure you have an open circuit somewhere. Test out your windings.

E. G. Cunningham, Illinois:

A. Your aerial would be slightly improved if the wires were spaced  $2\frac{1}{2}$  feet instead of  $1\frac{1}{2}$  feet. Otherwise your antenna system is excellent.

Q. Describes in detail his transmitting set, in general of excellent possibilities, but only gets sixty miles from it (1 k.w.) and wants to know the trouble. We offer the following comment:

A. (1) Primary of your oscillation transformer is of  $\frac{1}{2}$ " ribbon, and second-

ary of  $\frac{3}{8}$ " ribbon. This is ridiculous for 1 k.w. Primary should be at least 1" and very preferably  $1\frac{1}{2}$ " wide, secondary at least  $\frac{3}{4}$ " and preferably 1". (2) Adjust your rotary gap until the rotor just clears the stationary electrodes. (3) You use  $1\frac{1}{2}$  turns primary, entire secondary, and 1" of coupling between the windings. There is your trouble—in the coupling. It is impossible to operate satisfactorily with this close a coupling, even tho it gives the greatest total antenna current. Your radiated wave we are sure is not the wave length of your aerial circuit, but has two frequencies and in all probability the main one is up somewhere around a thousand meters so no wonder you are not heard by amateurs. See page 19, July QST, and Editorial entitled "QRM", page 14, November QST. As a starter, separate your pancakes six inches and carefully readjust until greatest indication shows on a HWA in ground lead. Never mind if it is only a fraction of the reading you get when the pancakes are close; it will be in ONE SHARP WAVE now, and will be heard.

M. W. Stormer, New York:

Q. Several local men who expect to use spark coils for transmitting are interested in a good break-in system. Will you kindly give me an effective and practical circuit that will cover their needs.

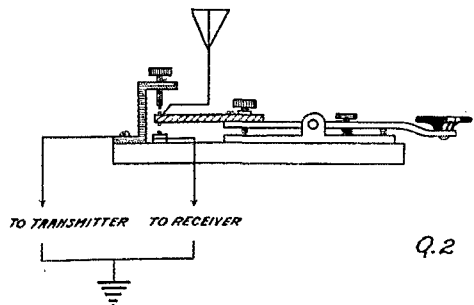

Q.2

A. For very small powers the extremely simple arrangement of an insulated extension on the rear of the key, as shown, is satisfactory. In general, however, attachments to the key are not satisfactory,

because if adequate they are too cumbersome, and the only genuinely satisfactory systems we have seen are those employing a multi-contact relay switch, the contacts of which can be utilized to perform any desired functions. For a variety of such hookups and information, see Leon W. Bishop's Handbook.

Dr. Benjamin Rouslin, Rhode Id:

A. Your 150' single wire, 50' high at one end, will not make a very satisfactory transmitting antenna, but will cover short distances. We believe you should be able to transmit on 200 meters without a series condenser, tho by a rather close margin.

A. Your closed-circuit capacity will depend on the secondary voltage. With a spark coil, two sections of Murdock moulded condenser should be about right. With a transformer it will vary, roughly .004 to .008 mfd., depending on voltage and tone frequency.

Geo. C. Sprouls, jr., Penna.:

Q. Asks regarding relative merits of rotating disc and rotating arm in gap construction, etc.

A. We do not understand how your disc of the saw-wheel type can have sparking points  $\frac{1}{2}$ " diam. by  $\frac{1}{2}$ " long; or do you refer to the stationary electrodes? In general, the rotating arm has the advantage of lightness, making it convenient for a very small powered driving motor, but has the distinct disadvantage of wasting precious inches of circuit length in the long leads to the various stationary electrodes. We advise the disc, either saw-tooth, cut from a metal disc, in which case use aluminum for the rotor and copper for the stationary electrodes; or with "spark-thru" plug electrodes of brass, like the illustration on page 56 of November QST.

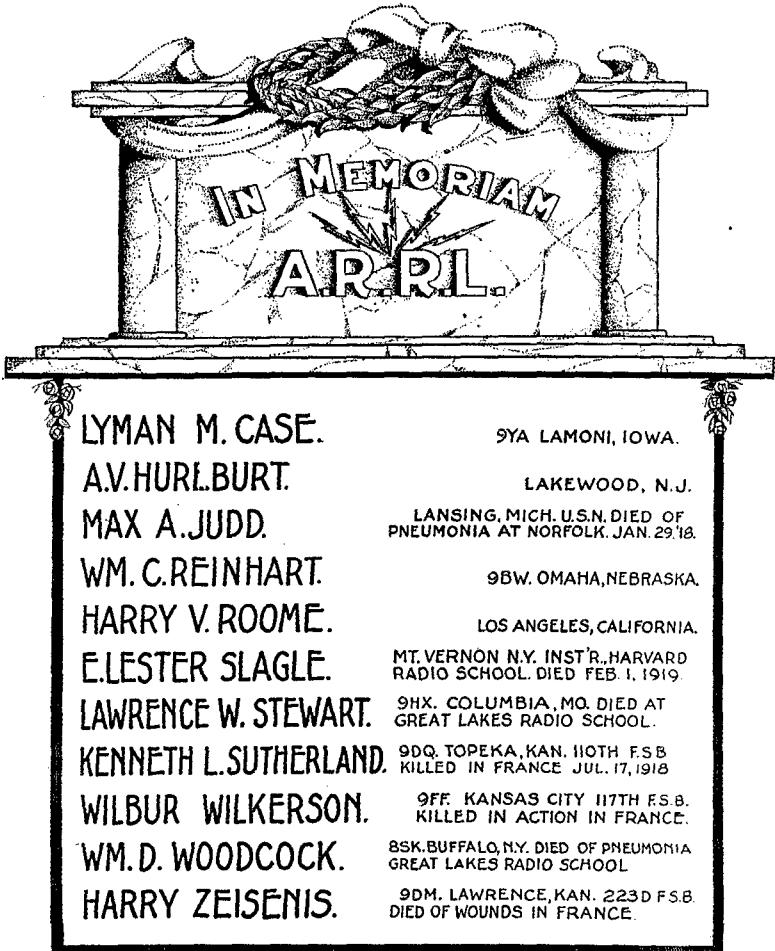



# An Audion Oscillator and Tone Circuit

By M. B. Sleeper

**T**HERE is one dark alley of radio work which has never been cleaned up. That is the buzzer. With all the things that have been done to make radio equipment safe, sane and dependable, no one has produced a buzzer that will always buzz steadily. The addition of a small resistance coil and refinement in mechanical design have not wholly eliminated the danger of lost patience over the tone that will not stay still.

When anyone fails to make a thing work, they usually get an audion. In this problem, too, the V. T. comes to the rescue in the form of an audio frequency oscillator. While the device is almost as old as the audion oscillator itself, it is not generally understood or its value appreciated by experimenters. The audion buzzer will be described first, and, later, its uses discussed.

Fig. 1 is an ordinary oscillator circuit, except that a 75-ohm telephone is inserted in the plate circuit. Although high resistance phones can be used, the other is suggested as it is more convenient to leave in the circuit. The coil is of 2 milhenries inductance. It can be made by winding No. 24 s.s.c. wire in a groove  $\frac{1}{2}$  inch wide by  $\frac{1}{2}$  inch deep, cut in a disc of wood 3 inches in diameter. A tap is brought out at the middle of the winding. A 0.5 mfd. paper condenser is shunted around the coil. Another way to make the coil, to give an adjustable pitch, is to wind a tube 3

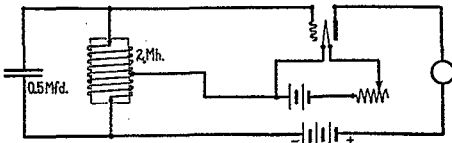

Fig. 1

inches in diameter with No. 28 s.s.c. wire for a distance of  $3\frac{1}{2}$  inches, fitting the coil with a slider or taps and a switch.

As the filament is lighted, the telephone will give a clear, steady note, beautiful to hear, and excellent to copy or test by. Used for a buzzer test, a single wire, connected to the filament, should be run to the apparatus.

Under some conditions, a calibrated audio frequency oscillator is needed. Then a condenser box can be substituted for the fixed type mentioned, and, by means of tuning forks, several points calibrated to make a curve. The author, in working on T. P. S. buzzers, has connected one telephone to the T. P. S. set, and another

in the oscillator circuit. Then, holding the telephones together, adjusted the condenser until a beat note was heard. Reference to the calibration curve gave the frequency of the buzzer. In justice to the Western Electric Company, who made the T. P. S. sets, it should be said that the tones were steady enough to take such a measurement.

Many experimenters are using an oscillating audion circuit as a wavemeter. There again is a buzzer problem. The tone circuit is just the thing. Fig. 2 shows how it is connected. The circuits of the wavemeter and tone circuit are alike,

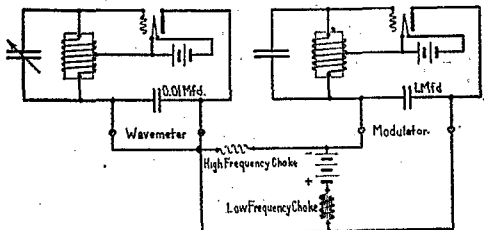

Fig. 2

except that the former has a variable condenser of comparatively small capacity. In the leads connecting the plate circuit, a small inductance, made by winding 150 turns of No. 28 s. s. c. wire on a thread spool, is inserted. This is to prevent the high frequency current of the wavemeter from backing into the tone circuit. An iron core choke coil is put in the battery circuit. It should have about 500 turns of No. 28 s. s. c. wire on a core 3 inches long and  $\frac{1}{2}$  inch in diameter. The purpose of the choke is to keep the current constant.

It will be found that a modulated wavemeter of this sort gives a pure wave, with a clear note at resonance. If it is desired, the filaments of the tubes can be put in series or parallel, to do away with the extra battery.

For undamped wave telegraphy, the necessity for an audion receiver can be overcome by using the tone circuit, connected to the transmitter as in the wavemeter circuit. It is necessary, however, for perfect modulation, to have at least as many or more tubes in the modulator as in the transmitting oscillator. They should be joined in parallel, grids to grids, plates to plates, and filaments in series or parallel.

There is no note clearer or better to read than that obtained in this way. The tuning is very sharp at the receiver, whether a crystal or straight audion circuit is used.

## How to make a Simple Variometer

By *John M. Clayton*

**T**HE usual type of variometer which the amateur has constructed heretofore is made by winding the stator right over several layers of tape wound on the rotor, then casting the whole in wax so as to support the stator, and pulling out the tape to provide the clearance for rotation. The objection to this method is that if the windings ever become loose there is no way to get to them to reshellac them. The following method of casting entirely precludes this trouble, as the rotor can be entirely removed from the stationary windings if desired.

The variometers described when used in the grid and plate circuits of a regenerative set will tune from 180 meters to about 600 meters in conjunction with a secondary of 40 turns of No. 24 S. C. C. wire on a 3-inch cardboard tube.

First a wooden form is turned for the rotor,  $4\frac{1}{2}$  inches greatest diameter, and  $2\frac{1}{2}$  inches wide, and with an open center. This allows a winding space of  $1\frac{1}{4}$  inches on each side, in which is wound 30 turns of No. 19 S. C. C. magnet wire. The whole form is given a heavy coat of shellac and allowed to become perfectly dry. A layer of cotton tape is then wound in and out the center of the "ball" so that it covers the entire surface of the winding, and in such a manner that when the casting has been made the tape may be cut and pulled out. Over the tape is wound, circumferentially, a layer of heavy smooth cord, and over this another layer of cotton tape. Over the second layer of tape wind a layer of adhesive tape with the adhesive side up. This is to hold the stationary winding in place, and 29 turns of No. 19 S. C. C. magnet wire are wound on each side of the form to compose this winding. Shellac and let dry thoroughly.

So far the process has been similar to the usual method of winding. Now make two small wooden boxes whose depth equals the width of the wire on one side of the winding (not the width of the whole form). They should be square, just large enough to clear the windings, and with a circular hole in the square side (the bottom) just large enough to fit the windings. Lay the rotor down on a pile of papers and set the first box in place, open face down, around it. Cut small wooden blocks the thickness of the space between the windings and place these on the box around the form. Then set the second box on these blocks, open side up. This will give two boxes which "cover" the width of the windings on the form, with a space between the boxes the same

as the space between the windings. A piece of cardboard is cut to fit in the top box as a lid, provided with a hole for admitting the wax. Now melt battery sealing wax or other similar compound and pour into the top box. After this has hardened, turn the whole thing over and repeat the process with the other box.

When the wax has hardened, cut the adhesive tape and fold back the edges out of the way. The last layer of tape, the cord, and the first layer of tape are successively cut and pulled out. We now have the rotor as it originally was, and the stationary winding in two sections, each half in a box. Make two bearings out of  $\frac{1}{8}$  inch brass, about  $\frac{1}{2}$  inch wide, and screw to front and back of the boxes to serve as bearings for the rotor shaft. The rotor may be easily aligned by changing the bearings.

### MR. AMATEUR

HIGH FREQUENCY CABLE—(LITZ).  
16-3-38 and 16-2-38 D. S. C. Enameled  
GREY SEAMLESS CARDBOARD TUBES  
Bakelite and rubber panels. Radio Call 1FJ.  
Write for circular on Honeycomb Coil Mounting  
—it will interest you. Wholesale and retail.

A. T. HOVEY

61 Belvidere Street, Near Mechanics Bldg.,  
BOSTON, MASS. (Open Evenings)

## We Are Ready For You!

Our Shop is in holiday attire—our stocks are complete. We are ready to take care of your needs—Any piece of radio apparatus manufactured can be supplied you NOW. From aerial to ground. We have it. Write now. Our PERSONAL ATTENTION is a guarantee of our SERVICE.

### The Radio Apparatus Service

"A Supply Company for the Radio Amateur"

H. H. MITCHELL, Sales Mgr.

DEPT. "A"

Room 803, Union Savings Bank Bldg.

WASHINGTON, D. C.

A no better Christmas remembrance to "Brother 'Ham'"

**Be Sure of Your Wave Length!**

*You can send with absolute certainty of conforming to regulations when you use the new*

**“AMRAD”**

**DIRECT READING**

**WAVEMETER**

*Range, 150 to 300 Meters*

*Accurate*

*Simple*

*Reliable*

**Price**

**\$5**

*Extremely easy to use. Flashlight bulb indicates resonance and dial shows wave length directly. A binding post allows connection of crystal detector and phones to calibrate receiving equipment.*

*If your Radio Dealer cannot supply you, order from us direct, but send us his name*

*Address Department R 15*

**AMERICAN RADIO AND RESEARCH CORPORATION**

**21 PARK ROW, NEW YORK, N. Y.      Laboratory at Medford Hillside, Mass.**

# RADIO APPARATUS

Distributors of all Prominent makes:—  
De Forest, Grebe, Murdock, Wireless Specialty, General Radio, Clapp-Eastham, Brandes, Acme, Audiotron Sales, Federal Tel. & Tel., Arnold, Wireless Press, etc., etc. You can place your orders direct from their catalogs and secure immediate delivery.

**LARGEST AND BEST STOCK OF ANY HOUSE IN NEW ENGLAND.**

De Forest Honeycomb wound inductance coils.

Cat. No.	Appx. Ind.	Appx. W. L. range with .001 Var. Cond..	Price
L25	.040	170-375	\$1.30
L35	.075	200-515	1.35
L50	.15	240-730	1.43
L75	.3	330-1030	1.45
L100	.6	450-1460	1.50
L150	1.3	660-2200	1.77
L200	2.3	860-2850	1.80
L250	4.5	1120-4000	1.90
L300	6.5	1340-4800	2.00
L400	11.	1860-6300	2.08
L500	20.	2340-8500	2.18
L600	40.	2940-12000	2.60
L750	65.	3100-15000	2.70
L1000	100.	5700-19000	2.95
L1250	125.	5900-21000	3.25
L1500	175.	7200-25000	3.50

POSTPAID TO ANY PART OF THE U. S. OR CANADA.

Prices on Litz wound coils can be secured on request or by reference to the De Forest catalog.

NOTE:—The Inductance values and Wave-length ratings of these coils are approximate.

Cat. No. LC-100 Inductance coil mounting without base but with gears, to hold three coils \$8.00

Shipping Weight 3 lbs.

Cat. No. LC-101 Same as above but mounted on oak base \$9.60

Shipping Weight 4 lbs.

Cat. No. ULC-100 Same as LC-100 but mounted on unit panel \$8.60

Shipping Weight 3 lbs.

## GREBE STANDARD DIALS WITH KNOB COMPLETE.

Suitable for variometers, couplers, condensers, etc.

Cat. No. PDA	0°-100°	4 Inches Diameter	Bakelite	\$3.00
Cat. No. PDB	0°-50°	4 " "	" "	2.50
Cat. No. PDC	0°-100°	3 " "	" "	2.65
Cat. No. PDD	0°-50°	3 " "	" "	2.25

POSTPAID TO ANY PART OF THE U. S. OR CANADA.

NOTE:—These dials are used on all Grebe apparatus.

EXCLUSIVE DISTRIBUTORS OF GREBE PRODUCTS IN NEW ENGLAND.

Remember this material is carried right in stock and shipped the same day as order is received. GIVE US A TRIAL.

## F. D. PITTS CO. INC.

12 PARK SQUARE,

Dept. A,

BOSTON, MASS.

**RADISCO  
COILS**

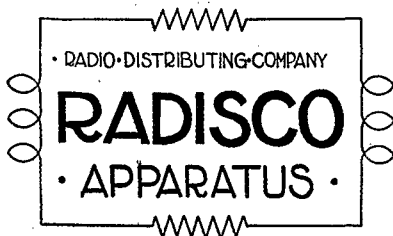

**RADISCO  
BETTER  
"B"  
BATTERY**

**DO** you know the Radisco Agent in your vicinity? Here are some of them. Go to them for reliable apparatus.

**ALBANY, N. Y.**

E. L. Long,  
21 Magnolia Terrace

**ATLANTIC CITY, N. J.**

Independent Radio Supply Co.,  
118 So. N. J. Ave.

**BROOKLYN, N. Y. CITY,**

Kelley & Phillips Electric Co.,  
312 Flatbush Ave.

**BRONX, N. Y.**

Amateur Wireless Equipment Co.  
1390 Prospect Ave.

**BOSTON, MASS.**

Atlantic Radio Co.,  
34 Batterymarch St.

**CHICAGO, ILL.**

Chicago Radio Laboratories,  
1316 Carmen Ave.

**CANADA, Quebec, Bienville,**

Canadian Radio Mfg. Co.

**McKEESPORT, PA.**

K & L Electric Co.  
427 Olive St.

**NEWARK, N. J.**

A. H. Corwin & Co.  
4 West Park St.

**NEW ORLEANS, LA.**

L. A. Rose,  
4323 Magnolia St.

**NEW CASTLE, PA.**

Pa. Wireless Co.,  
507 Florence Ave.

**PROVIDENCE, R. I.**

Rhode Island Elec. Co.,  
45 Washington St.

**PITTSBURGH, PA.**

The Radio Electric Co.,  
4614 Henry St.

**SCRANTON, PA.**

Shotton Radio Mfg. Co.  
8 Kingsbury St.

**WASHINGTON, D. C.**

Nat. Radio Supply Co.,  
1405 U St., NW

SOME GOOD TERRITORY OPEN TO LIVE AGENTS. WRITE FOR PROPOSITION.

**RADIO DISTRIBUTING COMPANY**  
**NEWARK, N. J.**

# STUDY WIRELESS

*Under former U. S. Radio Inspector, New England District*

The DEMAND for PROPERLY CERTIFICATED RADIO OPERATORS caused by the enlarged and constantly growing MERCHANT MARINE provides IMMEDIATE EMPLOYMENT for graduates of ANY SCHOOL, who secure their licenses, with ALL WIRELESS TELEGRAPH COMPANIES.

A course at THIS SCHOOL under INSTRUCTORS with LONG EXPERIENCE IN TEACHING RADIO, together with our new 500 CYCLE INSTALLATION, assures the student of being properly trained to qualify for FIRST GRADE COMMERCIAL LICENSE.

Besides the regular prescribed course, we conduct a separate RADIO THEORY COURSE, both DAY and EVENING, for those who have had previous training and wish to qualify in a few weeks to fill some of the many vacancies in the MERCHANT MARINE. Excellent opportunity for men just out of the SERVICE.

Positions pay from \$100. to \$125. per month, including food and quarters. All responsible radio positions today demand the possession of a FIRST GRADE COMMERCIAL LICENSE.

Students may enter any Monday. Day and evening classes.

Free classes for AMATEURS on Saturday morning at 10 A. M.

COMMERCIAL, RAILROAD AND BROKERAGE TELEGRAPHY.

Inspection invited.

## MASSACHUSETTS RADIO and TELEGRAPH SCHOOL

18 BOYLSTON STREET, BOSTON, MASS.

(Lt) R. F. TROP

ARTHUR BATCHELLER

G. R. ENTWISTLE

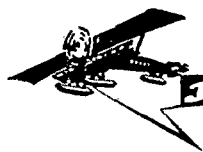

**EASTERN  
RADIO**

**INSTITUTE**

899 BOYLSTON ST.  
BOSTON, MASS.

**RADIO**



TEL.  
BANK BAY  
5964

## ANNOUNCEMENT!

One of the largest Wireless Telegraph Companies in the country, operating hundreds of ships to all parts of the world, has GUARANTEED to place in good positions EVERY MAN who graduates from the EASTERN RADIO INSTITUTE. We are POSITIVELY the ONLY school in New England who can make this statement and guarantee every man a position. When you realize that it only takes six months in the Day School or nine months in the Evening school to accomplish the work and that the salaries for beginners are from \$100 to \$125 per month, food and quarters included, and that the entire expense of the course can be returned to you in one month's salary, doesn't this appeal to you? Remember we are the OLDEST, LARGEST, and BEST EQUIPPED telegraph school and have THOUSANDS of satisfied graduates to our credit. THIS SPEAKS FOR ITSELF. Day And Evening Classes. Start any Monday. Other courses for Men and Women in Commercial, Railroad and Brokerage telegraphy. Special afternoon and Saturday classes for Amateurs now forming. Our prospectus for the asking.

# WIRELESS SPECIAL

COMFORTABLE

**D H E**

3200

**O H M**



TEN DAYS  
TRIAL

SOFT TONE

**HEADSET**

**\$6.00**

WE STOCK ALL STANDARD RADIO APPARATUS AND PARTS

CATALOGUE WILL BE OUT DECEMBER 1ST

**DOUBLEDAY-HILL ELECTRIC CO.**

RADIO DEPT.

719-21 LIBERTY AVENUE,

PITTSBURGH, PA.

## NEW ORLEANS

WIRELESS SUPPLIES AND  
MINERALS OF ALL DESCRIPTIONS

**L. A. ROSE**

4323 MAGNOLIA STREET

NEW ORLEANS, LA.

SEND 6 CENTS FOR CATALOG

## WIRELESS APPARATUS

We Carry a Full Line of Wireless  
Supplies for the Amateur.

**JAMES W. POOLE, Inc.**

64 Kingston St., Cor. Bedford

Boston, Mass.

Est. 1887.

# LEARN WIRELESS TELEGRAPHY

*Fascinating and Educational Work—Big Salaries—Prepare Now*

The United States Shipping Board is making heavy demands upon us for **Dodge-trained** wireless operators. Travel all over the world, secure, free, unsurpassed living accommodations and earn a big salary.

**We Also Teach Morse (Wire) Telegraphy and Railway Accounting**

**School established 45 years.** Endorsed by wireless, railway and telegraph officials. Low rates. Students can earn living expenses while attending school. **Catalog Free. Write Today.**

**Dodge's Telegraph and Wireless Institute**

**27th St.**

**Valparaiso, Indiana**

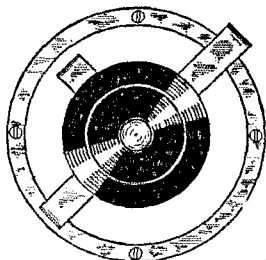
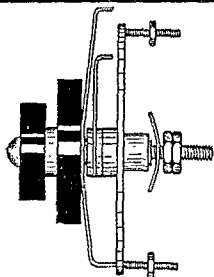

SWITCH CONTACTS

Brass finish 2c. Nickle finish 4c. POSTPAID

**THE WILCOX LABORATORIES**

LANSING,

DEPT. H

MICHIGAN

## WILCOX PANEL SWITCHES

TYPE 102

A compound switch especially suitable for primary of loose couplers.  $1\frac{1}{2}$ " outside radius.

Polished brass finish... POSTPAID... \$1.10  
Nickle plated finish... POSTPAID... 1.25

TYPE 101

A beautiful and efficient standard switch for general use. Furnished in two sizes.  
 $1\frac{1}{2}$ " Radius, brass finish, POSTPAID, \$0.50  
 $1\frac{1}{2}$ " Radius, nickle finish, POSTPAID, .60  
 $1\frac{1}{2}$ " Radius, brass finish, POSTPAID, .40  
1" Radius, nickle finish, POSTPAID, .50

OTHER TYPES

of switches, scales, panels, variometer parts, etc. are listed in our loose leaf catalog. Sent for five cents in stamps.

**RELIABLE DEALERS WANTED**

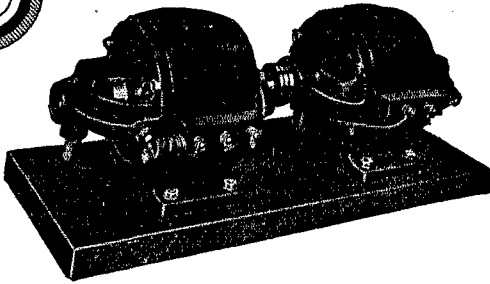

# RADIO INTERNATIONAL RADIO

## HIGH VOLTAGE—DIRECT CURRENT MOTOR GENERATORS

**PRICE \$75.00 F.O.B. FACTORY  
SHIPPING WEIGHT 80 LBS.**

The generator is compounded to insure constant voltage under variable load. It is furnished to operate on either D.C. or A.C.; a shunt motor being supplied for D.C. and an induction motor for A.C. The generator is equipped with a commutator of 48 segments reducing the commutator hum to a minimum.

Unit is complete with insulating coupling and mounted as illustrated on a finished base 8" x 20". Shipment can be made immediately.

The motor generator illustrated above is only ONE of the many newly designed radio specialties which we have ready for you. Write us for descriptive bulletins which are being issued covering all International Radio products. Address Dept. No. 23

This unit has a normal output of 100 watts (200 milliamperes at 500 volts) with a voltage range of 230 to 500 volts.

**International Radio Telegraph Co., 326 BROADWAY  
NEW YORK CITY**

# G. A. STANDARDIZED SUPPLIES

## STANDARD BAKELITE PANELS.

The highest grade of insulating material obtainable. The use of standard sizes of panels makes possible the interchangeable design of equipment.

Size	1/4 in. Thick	Weight	3/16 in. Thick	Weight	1/4 in. Thick	Weight
5x 5 ins.	\$0.60	1 lb.	\$0.88	1 lb.	\$1.16	1 lb.
5x10 ins.	1.18	1 lb.	1.76	1 lb.	2.30	2 lb.
10x10 ins.	2.35	1 lb.	3.50	2 lb.	4.60	2 lb.
10x15 ins.	3.50	2 lb.	5.25	2 lb.	6.85	3 lb.

Accurately cut, always kept in stock. Shipping charges extra.

## G. A. STANDARDIZED B BATTERIES, 22.5 VOLTS

Built to specifications of U. S. Signal Corps and Bureau of Steam Engineering. Made by the formula used for 90% of the B batteries by the Government. G. A. batteries last longer and are cheaper than flashlight cells. Made for V.T.'s, and Audiotrons. Need no voltage adjustment tho they can be used with a potentiometer. Two Navy type batteries with one V.T. will transmit 2 to 5 miles telephone, or 4 to 10 miles telegraph. Three or four will give much greater range.

**SIGNAL CORPS TYPE**, 3 1/4" long, 2" wide, 2 1/4" high, operates one V.T. 250 hours continually, average life 3 months, \$1.50, weight 1 pound. Mailing extra.

**NAVY TYPE**, 6 1/2" long, 4" wide, 3" high, operates one V.T. 1,000 hours continually, average life 10 months, \$2.50, weight 5 pounds. Mailing extra.

## G. A. STANDARD H. F. CABLE FOR RECEIVERS AND V. T. TRANSMITTERS

10 No. 38 cable, D.S. covered, for receiving coils. Good for 2-bank winding. 40 turns per inch. Price per 100 feet \$0.50

20 No. 38 cable, D.S. covered. Gives greater signal strength and sharper tuning than solid wire. 35 turns per in., 100 feet \$0.85

3 x 16 No. 38 cable, D.S. covered. Must be used for V.T. transmitting inductances for maximum efficiency 17 t.p.i., 100 feet \$1.60

## SEND 3c STAMP FOR THE G. A. INTRODUCTORY BULLETIN

The new edition has been delayed by the printers' strike in New York. Copies will be sent out as soon as received from the press. Send in your order now.

**G. A. SUPPLIES ARE SOLD BY MAIL ONLY. NO GOODS SOLD AT THE NEW YORK OFFICE.**

**MONEY BACK  
GUARANTEE ON  
EVERY ORDER**



**QUICK SERVICE  
ABSOLUTE  
RELIABILITY**

# The General Apparatus Company

158 East 18th Street,

New York City



## CLASSIFIED ADVERTISEMENTS

Five cents per word per insertion, in advance. Copy must be received by the 10th of month for succeeding month's issue.

**TELEGRAPHY** (both Morse and Wireless) **AND RAILWAY ACCOUNTING** taught thoroughly and quickly. Big salaries now paid. Great opportunities. Oldest and Largest School—est. 45 years. Catalog free. Dodge Institute, 28th St., Valparaiso, Ind.

Antennas built and erected. Masts put up. All kinds of Antennae construction work done. Will go anywhere in New England. Saturday afternoons and Sundays preferred. J. Limone, 53 Granville Ave., Medford, Mass.

**FOR SALE:** New 15,000 meter loose coupler—\$20 Alden Specht, 2 Kimball Rd., Watertown, Mass.

**FOR SALE OR TRADE:** One Volume Library Book. The book for students. Costs \$7.50. Want radio apparatus in Trade. Henry Simonson, Box 355, Alden, Minn.

**PANEL TRANSMITTING SETS:** Panel type transmitting set for one inch coil or less. Adjustable condenser, oscillation transformer, pancake type, and gap with large radiating surfaces, mounted on a panel. All instruments are designed for low power Amateur work and being of panel design incorporates efficiency and neatness. Price postpaid \$12.00. Louis A Jaques, 51 Jaques Street, Somerville, Mass.

**FOR SALE:**—Receiving apparatus, 1 KW transformer \$20, Medical Vibrator Shocker \$5, Dial Contacts 3/16" (brass) \$0.03 each. Edw. T. Chappell, 301 South River St., Lansing, Mich.

**FOR SALE:**—Complete transmitting set, regenerative receiver, wave meter, hot wire ammeter, several vacuum tubes. Information on request. J. A. Crowds, 5047 Wshington Ave, St. Louis, Mo.

**FOR SALE:** Transformer parts, 10-unit 1 K.W. secondary, 34,000 turns No. 32 and core insulation, \$15, primary 300 turns No. 14, tapped, \$4; 6-unit 1/2 K.W. secondary, 20,000 turns No. 34, core insulation, \$7.50, primary 250 turns No. 16, \$2. Bartholomew, 349 W. 79th, Los Angeles.

**FOR SALE:** 10 kilowatt second hand Clark wireless transformer, sealed in case; in first class working condition; operates on 110 volts alternating current; a gigantic bargain at \$50.00; cost over \$500.00. Sydney Friedrich, 350 East Commerce Street, San Antonio, Texas.

**FOR SALE:** Holtzer-Cabot phones, 3000 ohms, \$6.50; Loose Coupler, 2600 meters, \$5.00; Blitzen Variable Condenser, 17 plate, \$2.50; 43 plate, \$3.25; Galena detector, \$1.75; AudioTone, perfect condition, \$4.00; Vacuum Valve panel detector, \$3.75; Marconi-Victor Records, \$4.00. All perfect condition. J. G. Dilworth, 518 Roslyn Place, Pittsburg, Pa.

**FOR SALE:**—Murdock "Famous" Receivers cost \$8.50, sell \$5.00, 2 Variables cost \$4.50, sell \$3.00 each, 30 different Electrical Experimenter Magazines, \$3.00, Everything first-class. Theodore Olsen, 528 Market, Portland, Ore.

## FRIENDS OF OLD We Are With You Once More

"PACIFIC RADIO NEWS" will resume publication. All subscribers on our files will receive their copies.

Next issue will be ready for distribution on December 15, 1919.

**SUBSCRIPTION RATE \$1.50 per year. 15c per copy.** If you are not a subscriber send for a copy today.

## Pacific Radio Pub. Co.

50 MAIN ST., SAN FRANCISCO, CAL.

## AMATEURS!

Complete line of Radio Materials and all standard apparatus.

We have some new and interesting developments.

Write us your needs.

"RADISCO AGENCY"

## K. & L. ELECTRIC COMPANY

427 Olive Street,

McKEESPORT, PA.

**WANTED:** Have DeForest Unit three-coil geared mounting and electrolytic interrupter. Want Murdock antenna switch and oscillation transformer. P. O. Box 629, Hartford, Ct.

## PAPER TUBES

For constructing loose couplers, loading coils, variometers, etc., smooth, round, gray, seamless, tubes.

### FOR 3500 METER COUPLER

Primary 3 3/4" outside dia. 7" long—25c  
Secondary 3 1/4" outside dia. 6" long—20c

### FOR VARIOMETERS

Primary 4 3/4" outside dia. 2 1/2" long—12c  
Secondary 3 3/4" outside dia. 2" long—10c

### FOR LOADING COILS

3 3/4" Outside Dia. 14" long—40c

4 3/4" Outside Dia. 14" long—50c

Special Lengths Cut to Order

To 15" long 3 3/4" dia.—4c per in.

3 3/4" dia.—5c per in.; 4 3/4" dia.—6c per in.

All tubes have 1/8" wall.

IMMEDIATE SHIPMENTS, POSTPAID.

THE TAYLOR COMPANY, BOX 1043C,

LOWELL, MASS.

ALWAYS MENTION QST WHEN WRITING TO ADVERTISERS

## Laboratory Signs

Attractive 8" x 10" signs printed on high quality coated white cardboard in selected wordings for the electrical experimenter.

1. DANGER! HIGH VOLTAGE
2. EXPERIMENTAL RADIO LABORATORY  
NO ADMITTANCE
3. GOVERNMENT LICENSED RADIO  
STATION
4. DO NOT TOUCH THE INSTRUMENTS
5. PLEASE BE QUIET WHILE THE  
OPERATOR IS RECEIVING

15c EACH, ANY TWO FOR 25c

ALL 5 FOR 50c

# 3 Inch Dial Indicator

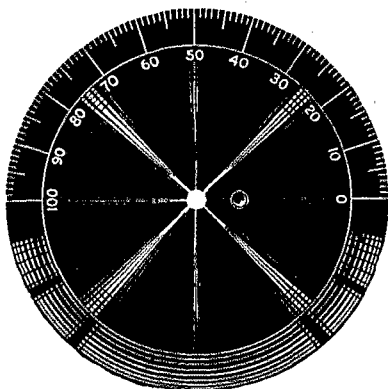

## FINE BLACK COMPOSITION DIAL

No. 66 without Knob \$0.75 postpaid

No. 67 Dial with Bakelite Knob 1.30 postpaid

FOR SALE BY ALL RADISCO AGENCIES  
AND BY

### A. H. CORWIN & CO.

4 West Park Street, Newark, N. J.



# UNIVERSAL SYSTEM RADIO APPARATUS

*Efficient equipment for all purposes*

*Damped and continuous waves*

*Send stamp for Catalog and mention QST*

Universal Radio Mfg. Corporation  
ELMIRA, N. Y.

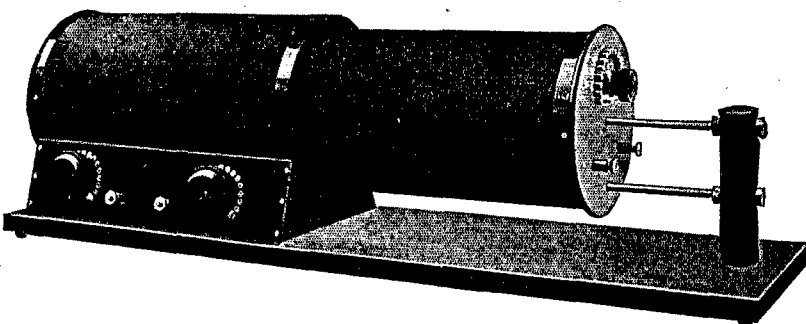

## Copy Signals

from  
High Power  
Arc Sets  
with

### Klitzen No. 102 Undamped Wave Coupler

Reasonable price brings it within range of all Amateurs. Will tune up to 17,000 meters and over. Has copied Nauen, Germany; Lyons, France; Rome, Italy; and Carnarvon, Wales without the aid of an amplifier.

Primary and secondary wound with double green silk covered wire on non-shrinkable bakelite tubes. All switches are of self cleaning type-insuring good contact—and are keyed so that they will always be firm and positive. Wood

work is ebony finished and hand rubbed. All metal parts high grade nickel-plated. A first quality, attractive, sensitive instrument—good enough for the expert—inexpensive enough for the amateur.

Price, complete.....\$35.00

Just Out—Catalog C—Write for it.

## KLITZEN RADIO MANUFACTURING CO.

1501 Flett Ave., Racine, Wis.

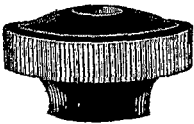

## AN EXAMPLE OF OUR VALUES

No. 838 Knob 1 1/4" dia.  
3/4" high 3/16" Hole

16c EACH---\$1.80 PER DOZEN

"We sell" phenol fibre for transmitting condenser dielectric

In addition to distributing the best grades of standard apparatus, we always have many exceptional values in slightly used instruments and have many specialties not sold to amateurs through usual sources.

**Send Us Ur List. What Do U Need ?**

**Radio Equipment Company**

630V Washington St., Boston, Mass.

## The "RVA" Service

is that we will sell you any piece of any make of RADIO APPARATUS on the INSTALLMENT PLAN. The RVA BULLETIN published each month, contains full details, our terms and a little of everything to make it of interest to you as an Amateur. Your name placed on the list on receipt of ten cents—stamps or coin.

**J. DONALD VANDERCOOK**

ONE PARKSIDE AVENUE,  
LOMBARD, ILLINOIS

## The Oldest Radio Supply House in New England

Agents for all reliable lines  
of apparatus

**GEO. S. SAUNDERS CO.**

168 Washington St. 11 Devonshire St.  
BOSTON, MASS.

## The Radio Engineering Co.

MANUFACTURERS  
OF



## RADIO APPARATUS

beg to announce their reorganization, and the opening of a show room and distributing centre

FOR THE SOUTH

of DeForest, Clapp-Eastham, Brandes, Stromberg-Carlson, Holtzer-Cabot, Dubilier, Marko, Burgess "B" Batteries, and all other standard radio products. Also the

"RECO KEY"

10 ampere size, Italian marble base, nickel plate or lacquered brass, no better key on the market at

PRICE \$6.50

Raw materials, binding posts, contact points, and apparatus made from your own specifications. Our new and revised catalog now on press mailed on receipt of 6c in stamps.

NOTE NEW ADDRESS

827 Madison Ave., Baltimore, Md.

## The Newest Radio Supply House in America But The Best

"OHIO" UNIT APPARATUS

OSCILLTRON VACUUM VALVE

CATALOG NOW READY

**A. G. PEOPLES & CO.**

1592 E. 86 ST., CLEVELAND, OHIO

## AERIAL WIRE

7 strands No. 22 pure copper. High tensile strength and 100% Radiation. Shipping weight 15 lbs. per 1000 feet. Postage extra. No C. O. D's. at this low price. Immediate delivery.

**1 CENT PER FOOT**

\$9.00 Per Thousand

**GALVANIZED GUY WIRE**

7 strands 5/32 diameter 1 cent per foot.  
Single wire No. 12 1/2 " " "

**LEE A. BATES**

8 Moen Street. Worcester, Mass.

Call 1GY—A.R.R.L. Supt., Central Mass.

## 8,000 MILES

is the record (amateur) with our  
Audio-Tron Detector.

**THE GENUINE AUDIO-TRON  
DETECTOR - AMPLIFIER - OSCILLATOR**  
Price postpaid . . . . . \$5.00

Can we send you one C. O. D. ?  
No extra charge.

**Jensen Electric Co.**

RADIO APPARATUS

1949 Huron Street CHICAGO, ILL.  
TWO FILAMENT BULBS ONLY

# ANNOUNCEMENT!

Our new Catalog H ready for distribution December 15th. Contains complete line of parts, raw materials and instruments. 24 pages of material you cannot afford to miss.

Send 5c in stamps for your copy today and get on our mailing list for future bulletins without charge.

**SHOTTON RADIO MFG. CO., P.O. Box 3, Scranton, Pa.**

BRANCH: 8 Kingsbury St., JAMESTOWN, N. Y.

## The Efficiency and Sensitiveness

Of vacuum tubes is retained or increased by repairing or replacing broken and burned out elements.

The establishment of a complete and modern high vacuum laboratory enables us to repair all types of tubes manufactured in the United States or Abroad.

### THE COST OF REPAIRING

Marconi V.T. .  
Western Electric  
General Electric  
DeForest  
Moorhead

Receiving Tubes \$4.50

Audiotrons  
Electron Relays

\$4.00

Small transmitting and foreign tubes \$7.50  
Power tubes 15.00

Burned out tubes purchased outright at 50c each. A limited number of repaired tubes on hand, guaranteed same as new at \$5.00 and \$4.50 respectively. Money refunded if not satisfactory.

**The Vacuum Tube Repair Company** AGENCIES  
DESIRED.

511 Perry Building  
OAKLAND, CALIFORNIA.

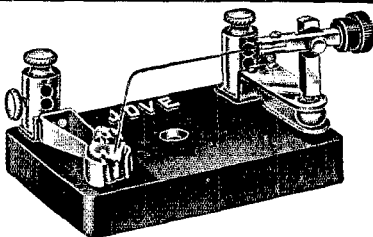

(Ghegan Patent)

Bunnell Keys, Transformers, Condensers, Spark-Gaps, Receivers, etc. are High Grade but Inexpensive.

Send Stamp for New Edition, 40 Q Catalog.

**J. H. BUNNELL & CO.**

**32 Park Place, New York**

**BUNNELL** *Instruments*  
*Always Reliable*

### THE JOVE DETECTOR

HANDIEST, HANDSOMEST AND BEST

Sample by Mail, \$1.44

Tested Galena Crystal 25c.

# The High Water Mark of Efficiency

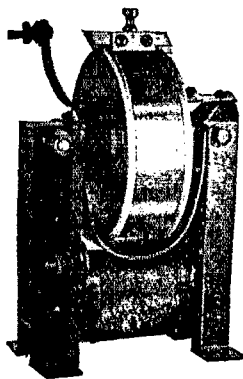

1/4 K.W. Special

For the amateur who is restricted we recommend our 1-4 K. W. Special Wireless Transformer which will equal the transmitting distance of an ordinary 1-2 K. W.

**POWER FACTOR 91 PER CENT.**

## THORDARSON ELECTRIC MFG. CO.

501 S. JEFFERSON STREET

CHICAGO, ILL.

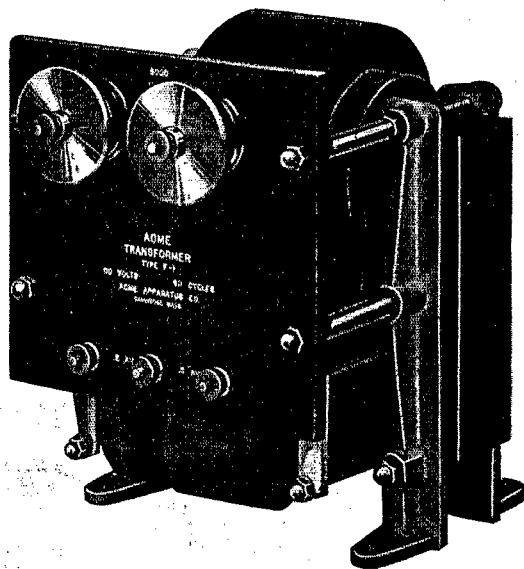

## GET WHAT YOU PAY FOR

*Amateurs within 5 miles of the Navy Radio Stations are limited in the amount of power they can use—1-2 K. W.*

It is therefore Important when Buying a Transformer to get one that will draw full Rated Power. The Acme Transformers do this on a Condenser of .007 MF.—Plenty Small enough for 200 Meter Work.

Our Transformers are all Tested under Actual Working Conditions, and each one is Tagged, Showing Actual Performance at Full Power.

They are also Provided with Extra Primary Binding Post for Low Power.

These are the Only Amateur Radio Transformers Now on the Market Properly Designed (Electrically) for use with Rotary Non-Synchronous Gaps, and they are Recommended solely for use in this way.

TYPE	INPUT		NET WEIGHT	PRICE
	FULL POWER	LOW POWER		
D-1	250 Watts	120 Watts	13	\$19.00
F-1	500 "	150 "	26	25.00
H-1	1000 "	200 "	48	38.00

These Prices are for 110 volt 60 cycles.

**ACME APPARATUS CO., 26 Windsor Street, Cambridge, Mass.**

A New  
Variometer  
for the  
Amateur

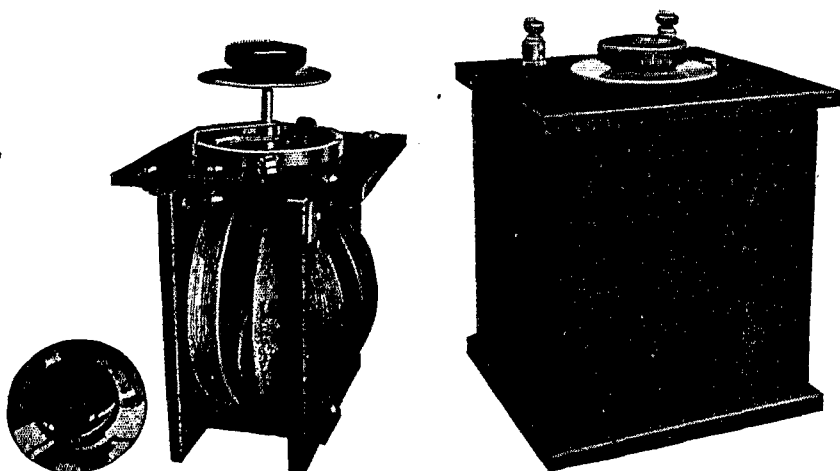

Type S.S. Variometer, in three sizes: maximum inductances, 1 millihenry, 5 millihenries, 20 millihenries.  
Mounted \$20.00; unmounted \$16.00.

Variometers provide an inductance as easily and gradually variable as a rotary condenser. They are the ideal inductance; efficient, no poor contacts, dead-end losses or capacity losses from multiple taps.

Clapp-Eastham Variometers are designed to give the amateur a Precision Instrument at a low price. Compact in size and beautiful in workmanship. Especially designed to minimize distributed capacity. Readily adaptable to panel mounting. Equipped with a special drum switch automatically actuated by the control knob, whereby the coils are in parallel the first half revolution providing an inductance continuously variable thru 360 degrees, giving double the range of adjustment available with other variometers.

Fully described, with other New Developments, in our interesting Bulletin Y.

NEW BULLETIN R OF RECTIFIERS FOR STORAGE BATTERY CHARGING NOW READY.

## CLAPP-EASTHAM COMPANY

141 MAIN STREET

CAMBRIDGE, MASS.

REMLER RADIO MFG. CO., 62 Post St., San Francisco, Cal., Pacific Coast Representatives

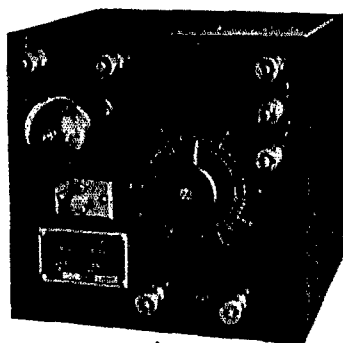

TYPE AD-1

TYPE AD-1 (For VT)—  
Without Tube \$11.00

TYPE AD-2 (With Sensitive  
High Voltage Adjust-  
ment, Without Tube) \$23.00

WRITE FOR OUR BULLETIN J-19.

## THE BEST AUDION DETECTOR VALUES IN AMERICA !

Our audion detectors, illustrated here, were scientifically designed for use with either the Marconi VT or the Audiotron, as shown. Construction in accordance with our well known high standard, BAKELITE PANELS, ENGRAVED SCALES, HARD RUBBER (not composition) KNOBS. Control Switch for Turning off Filament. Equipped with proper Grid Leaks and Mica Stopping Condensers.

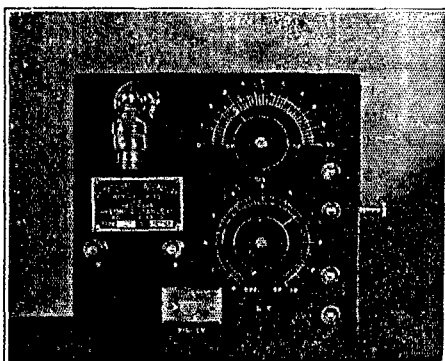

TYPE AD-2

CHICAGO RADIO LABORATORY 1316 Carmen Ave., Chicago, Ill.

# Initial Offering

# REMLER RADIO APPARATUS

Highest Quality at Quantity Prices

IMMEDIATE SHIPMENTS

Full Line Switches, Levers, Contacts, Binding Posts, etc.

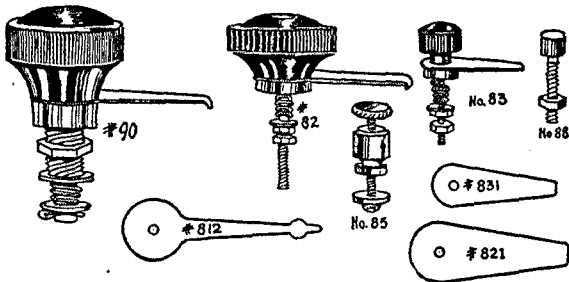

Build your own apparatus and save money. Send for list of parts.  $\frac{1}{4}'' \times \frac{1}{4}''$  or  $\frac{1}{4}'' \times \frac{1}{8}''$  contacts,  $\frac{3}{8}''$  6/32 stud and nut. Heavy polished nickel. Each 6c—per dozen 60c. No. 90 switch. Entirely new. Full  $\frac{1}{4}''$  steel bearing. Lever pinned on. Can never work loose. Large moulded knob, brass bearing, all metal parts polished nickel. Ideal for couplers, panels, loading coils, etc. Price,

\$1.25 each

## Remler Panel Type Rheostat

## Full Line Crystal Detectors

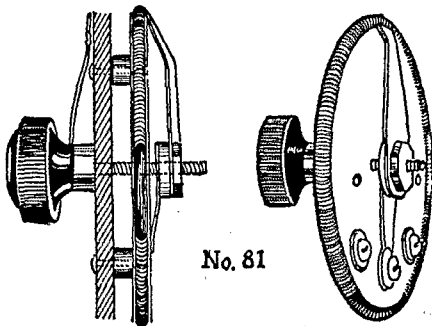

No. 81

The smoothest running rheostat on the market. Will increase efficiency of your tube control. Resistance mounted on bakelite ring. Unit cheaply renewed. All metal parts nicked. Complete.....\$1.75 each

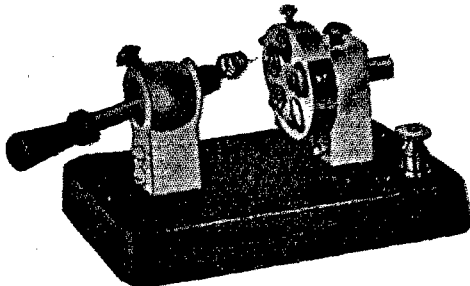

Four models. Mounted on moulded bakelite bases. Prices 95c to \$4.00. Cut shows \$4.00 model. All metal parts polished nickel. Turret head for 5 crystals. Send for bulletin.

## Coupler and Tuner Parts

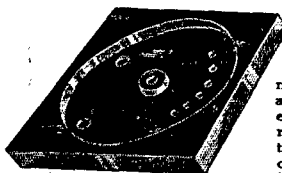

Complete sets of parts or individual items sold. Save money and build your own apparatus. Cut shows moulded bakelite secondary tuning or loading coil end. Cast in bosses for runner rods, switch and tie rod. Drill marks for contacts and binding posts. Two sizes.

$3\frac{3}{4}'' \times 3\frac{3}{4}'' \times \frac{1}{2}''$  to fit  $3\frac{1}{4}''$  tubing. Undrilled, 65c each.  $4\frac{1}{2}'' \times 4\frac{1}{2}'' \times \frac{3}{8}''$  to fit  $3\frac{3}{4}''$  tubing. Marked for 11 contacts, 90c each.

Send for complete parts bulletin.

Terms and Guaranty: All our apparatus subject to return and full credit if you are not fully satisfied. That is our confidence in the values we offer. All purchases delivered free when cash accompanies order.

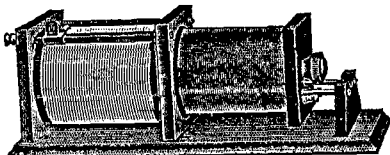

**Complete Line of Couplers**

Six different types. Wave lengths 1,500 to 15,000. Full navy and slider types. Parts sold if you want to build your own coupler. Price .....\$6.15 to \$35.00  
Send for coupler circular

DEALERS:--We want reliable representatives. Send for full details.

REMLER RADIO MFG. CO., 62 Post St., San Francisco, Calif.

# THE HEART OF THE WIRELESS

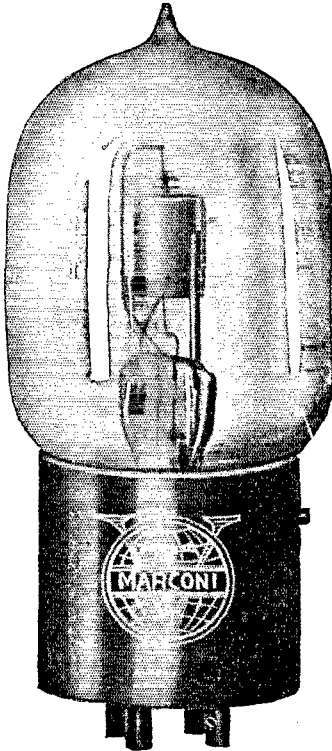

An Amateur Station  
Without a Vacuum Tube  
Is Years Behind the Times

## MARCONI V.T.

### \$7.<sup>00</sup> each

Under agreements recently effected the Marconi V. T. is the only vacuum tube, or audion, which may be sold to amateurs, laboratories, schools of instruction and experimenters.

---

THE APPROXIMATE  
OPERATING LIFE OF  
THE MARCONI V. T.  
IS 1,500 HOURS.

---

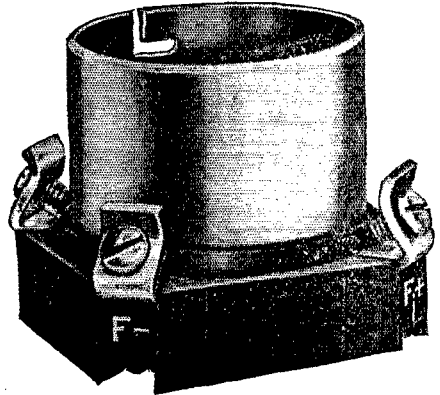

STANDARDIZED SOCKET \$1.50 additional

Fleming Pat. No. 808684  
DeForest Pat. Nos. 841387-879532

Class I.—Designed for use as a detector; operates with plate potential of 20 to 60 volts.

Class II.—Designed for use as an amplifier; plate potentials from 60 to 110 volts may be applied.

Tubes in either class may be used for detection or amplification, but those of Class I are best as detectors, and Class II tubes are superior as amplifiers.

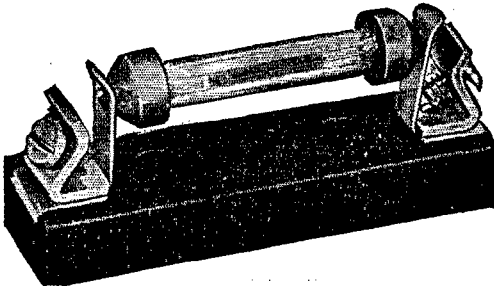

STANDARD RESISTANCE, COMPLETE \$1.00

Send all remittances with order to COMMERCIAL DEPARTMENT

## Marconi Wireless Telegraph Company of America

Sole Distributors for De Forest Radio Telephone & Telegraph Co.

227 BROADWAY, NEW YORK

RETAIL SALES AND EXHIBITION ROOMS, 25 ELM ST., NEW YORK

BRANCH OFFICES:

Schofield Bldg., Cleveland, Ohio  
American Bldg., Baltimore, Md.  
Insurance Exch. Bldg., San Francisco, Cal.

186 Federal St., Boston, Mass.  
301 Commercial Bank Annex, New Orleans, La.  
109 South 2nd St., Philadelphia, Pa.

The Marconi Resistance, connected in the circuit between the grid and the filament of the Marconi V. T., is made in the following standard sizes:

½ megohm, 1 megohm, 4 megohms, 6 megohms.

Resistances of any special fractional values up to 6 megohms can be supplied.



# Attention AMATEURS

You may want to purchase a coil, a transformer, a pair of phones, a battery or one of the many pieces of apparatus necessary to properly operate your set. What do you do? You write for catalogues—the result is you have a mass of data and just can't make up your mind what to buy and who to buy it from.

Our advice is **DON'T BUY IT** until you secure some expert's opinion on the piece of apparatus just suited to your needs.

Because we are partial to no particular manufacturer of wireless apparatus and because years of study and sales has enabled us to select wireless products with discrimination, we offer you absolutely without charge, the benefit of our **EXPERT INFORMATION BUREAU** which is maintained solely for the purpose of guiding the experimenter in the choice of apparatus which will, in our expert opinion, serve him best.

Of course we sell apparatus and there again our knowledge manifests itself because we carry the products of over 70 of the leading manufacturers of American made apparatus—therefore you are assured that what you buy is the attainment of modern efficiency in apparatus production.

We wish to strongly emphasize the fact that whether you buy of us or not we want to help you in your problems and the cost to you is but a two cent stamp. Write today for our catalogue.

**NATIONAL RADIO SUPPLY CO.,**

**"The Nation's Clearing House"**

Dept. 104, 14th and U Streets, Washington, D. C.

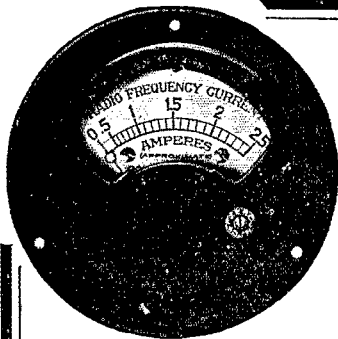

## Install a U. S. Army Hot-Wire Ammeter in Your Station

Imagine the increase in transmitting range one of these highly efficient Roller-Smith Hot-Wire Ammeters will bring you. A sharp wave, with maximum energy on one hump under all weather conditions; rapid adjustment to various wavelengths; increase or reduction of energy to work a certain station,—these are some of the advantages that can be yours.

**Regularly \$13 Our Special Price \$7**

These Ammeters are of the flush type and were made for the U. S. Army Air Service for use on fighting planes. The Armistice brought a cancellation of airplane contracts and these Ammeters could not be used. Each has passed the exacting Government tests and is in perfect condition. They have not been removed from their original cartons and are now ready for immediate shipment.

The scale reading is: 0—2.5 Amperes. Shunt giving double or triple this range, 75c extra.

Only by buying a large quantity of these Ammeters are we able to sell them at almost half the usual price. This is your opportunity to procure at an unusual bargain a standard U. S. Army Air Service Hot-Wire Ammeter. The supply is limited. Better get in on this today as there is a great demand for these instruments. Remit by check or money-order. Dealers write us, we have an attractive proposition for you.

**A. H. GREBE & CO., 74 Van Wyck Blvd., Richmond Hill, N. Y.**

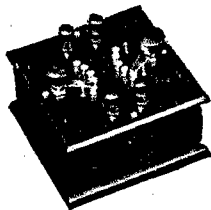

"WONDERFUL results," say the 120 users of our tuners. 20,000 meters C.W. tuners tested on a 25 foot aerial. 3000 meters NAA tuner brings sigs all over the room. 200 meter regenerative tuner great for relay work. Mount all three in a cabinet. Weight only two pounds. Price \$15 delivered to you. Agents and dealers wanted; get our interesting proposal. Tuners licensed under **MARCONI PATENT.**

### KNOCK-DOWN VARIABLE CONDENSERS

You assemble and save money. 5000 sold to date. No complaints. 43 plate, .001 M.F.—\$2.50; 21 plate, .0005 MF, \$2.25; 11 plate grid variable, \$1.75. Packed with full instructions.

**TRESCO SALES AGENCY, DAVENPORT, IOWA**

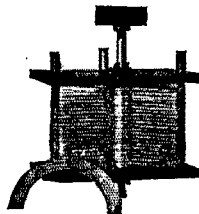

# WIRELESS AMATEURS

Send 2-cent stamp for free description of

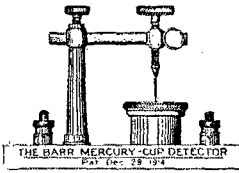

## The Barr Mercury-Cup Detector

The most efficient detector on the market. Tested by The Marconi Wireless Telegraph Co. and the United States Government.

Increases the efficiency of every wireless receiving set by making the signals clear, sharp and distinct. Instantly adjustable at a constant pressure.

## The BARR Mercury-Cup Detector

Dept. E, THE WYOMING,  
WASHINGTON, D. C.

**YOU ARE A RADIOIST** RADIOIST IS THE MODERN NAME FOR A RADIO AMATEUR "Radioist", originated by the International Society of Radioists, means one having a knowledge of radio, Chemist, telegraphist, so why not radioist? Simple, isn't it? And much better than radio amateur or radio "ham." By reading this advertisement you have learnt the modern name for a radio amateur:

### BY READING "THE RADIOIST"

the official organ of the International Society of Radioists, you will learn many new radio ideas since the contents of "The Radioist" are as original as its name and consist mainly of how-to-make-it articles, together with the latest, modern radio items for the radioists. "The Radioist" is published monthly and is sure to please either novice or expert as it contains live, peppy, simply written articles interesting to both.

### READ "THE RADIOIST" AND LEARN

how to construct an audion amplifying transformer; how to receive all the undamped stations on one audion using for an aerial one wire fifty feet long and only ten feet high; about the proposed international radioists relay; hundreds of other interesting facts, in fact all the latest and most modern ideas by being a reader of "The Radioist." Yearly subscription \$2.00.

**SPECIAL OFFER.** Special trial subscription, three months for 50 cents.  
**BE MODERN AND PROGRESSIVE.** Do not build your radio set until you've read the latest ideas in "The Radioist." Send your subscription, trial or regular, immediately and receive the "New Year" issue which will be a "rip-roarin" success. Delay means you're not up-to-date and are missing much, so act now and subscribe today.  
**INTERNATIONAL SOCIETY OF RADIOISTS,** Executive Headquarters, OMAHA, U.S.A.

THE NEWLY DESIGNED AND IMPROVED

## OSCILLTRON VACUUM TUBE

DETECTOR, OSCILLATOR AND AMPLIFIER

Signals have been received with this tube over a distance of 6000 miles on an indoor aerial.

To enable every amateur to use this superb tube it is now offered at a price within the reach of all.

POSTPAID  
**\$ 3.50**

**G. & M. SPECIALTY CO.**

737 Prospect Ave.,  
Cleveland, Ohio.

## Radio Sets, Parts and Supplies

Grade XX Bakelite Standard Panels (Smooth cut and squared) 5" x 5" x 3/16"—\$1.00 postpaid. In lots of six 20% off. Switches, Switch Contacts, Moulded Knobs and Binding Posts. Audiotron Bulbs, postpaid \$5.00.

Audion Control Panels for Audiotron & Marconi Bulbs. Regenerative Sets, Amplifiers and Transmitting Apparatus. Send stamp for circulars and description of Sets, Parts, and Supplies.

Address Sales Dept.

**FEDERAL RADIO AND RESEARCH LABORATORY**  
20 RUSH ST., SOMERVILLE, MASS.

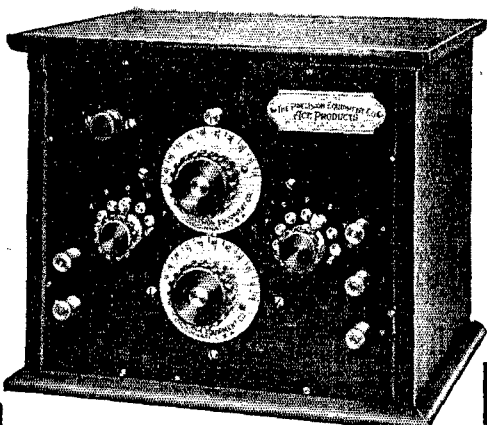

## RADIO AMATEURS!!

"ACE" Radio Equipment is a line of professional quality. Comprises complete radio telegraphic and telephonic transmitting and receiving apparatus for any power or wave range. Also all accessories and parts.

"ACE" Regenerative Receivers. "ACE" Audion Control Cabinets. Undamped Wave telegraphic and telephonic equipment for use with standard V.T. tubes. Audion Amplifiers using standard V.T. tubes.

We supply anything and everything the radio experimenter requires in wireless equipment and build complete outfits to order. We do not furnish any cheap or competitive materials.

THE PRECISION EQUIPMENT CO.,  
2437 Gilbert Ave., Dept. A, Cincinnati, Ohio.

## RADIO ELECTRIC

Offer

Genuine Guaranteed Audiotrons	\$5.00
Standard 22V.4A. B battery units	1.15
Baldwin Navy type	15.50
Small type	16.50
Receivers Improved model	17.50
Brass contact points, best made, dozen	.44
Composition knobs 10c to	.55
Composition Dials 3" (special)	.75
Remler Rheostats	1.75
Daynor Audion panels	15.00

"We make or sell Everything Radio"

We are distributors for all reliable manufacturers.

Special Apparatus designed and made to your order.

Send 10c for our catalogue.

**RADIO ELECTRIC CO.**

4614 HENRY ST., PITTSBURGH, PA.

## For Long Distance Relay Work

Big days are coming for the Relay League. Those members who have kept pace with war-time developments are the fellows you hear doing the real long distance work. Transformer input and wavelength are restricted but these obstacles are overcome by the



### Short-Wave Regenerative Receiver Type CR-4

A highly developed circuit of the continuously variable inductance type with an antenna series condenser. Range, 170 to 580 meters. An embodiment of the very latest achievements in electrical and mechanical design; capacity effects and other losses reduced to an absolute minimum. It is the ideal receiver for relay work. If you want to hear the fellows from coast to coast you need this receiver. Don't be deceived by manufacturers who imitate the distinctive appearance of Grebe apparatus. Send for free bulletin describing this and other Grebe models operating up to 20,000 meters, —complete catalogue, 10c.

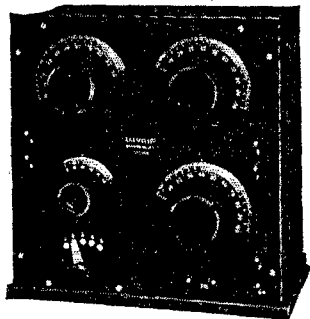

**A. H. GREBE & CO., 74 Van Wyck Blvd., Richmond Hill, N. Y.**

# Federal Audio Frequency Transformers

AND

## Radio Head Telephones

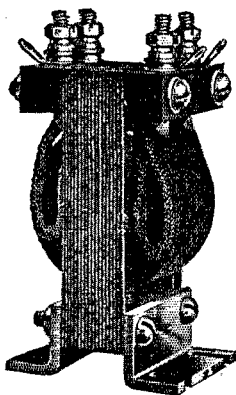

TYPE A  
No. 226-W  
\$7.10 EACH

Radio Apparatus You will  
Enjoy Having Because of

ITS

QUALITY and EFFICIENCY.

WRITE FOR BULLETINS

101W and 102W



LIBERTY A & N TYPE  
No. 53-W 2200 ohms  
\$12.50 PER SET

"ONE 226-W Transformer with ONE Marconi V. T. gives an energy amplification of 400 times. (Audibility amplification of 20 times.)

TWO 226-W Transformers with TWO Marconi V. T's. give an energy amplification of 160,000 times. (Audibility amplification of 400 times.)"

Federal Telephone and Telegraph Co. Buffalo, N.Y.

### SOMETHING NEW

## HIGHEST SENSITIVITY

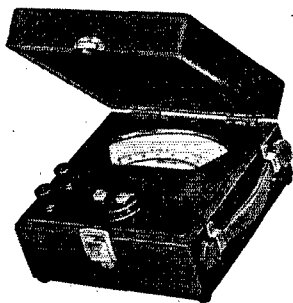

### Reliable Portable Instruments

Improvement in design and workmanship over previous instruments of this class has made it possible to obtain a still higher sensitivity yet

WITH MORE CONTROL

MICRO & MILLIAMMETERS

MILLIVOLT & VOLTMETERS

THERMO. JUNCTIONS IN VACUO

MANUFACTURERS

## Rawson Electrical Instrument Co.

4 NORFOLK ST., CAMBRIDGE, MASS.

Also Sole U. S. Agents For  
ROBT. W. PAUL LONDON

## Audion Lighting Special \$12.00

TWO-YEAR GUARANTEE.

Thin plates pasted with a hard yet very porous active material which reduces shedding to a minimum.

Weight and volume are correspondingly reduced. Cases of seasoned oak treated with acid-resisting compound. Best materials used throughout.

Type 6-RC was designed especially for use with VT's by the amateur of limited means.

Type 6-RW is intended for the same use but will give proportionately longer service per charge. Hydrometer free with each battery.

Repairs on all makes of storage batteries.

Watch this space for further announcements.

Type 6-RC..... \$12.00

Type 6-RW..... 17.00

Write us for prices on special sizes etc.

### WATSON-CLAY CO.

12 Yarmouth St., Boston, Mass.

TELS. Back Bay { 58577  
55065

Send 2c stamp for Bulletin 1.

## GOOD NEWS TRAVELS QUICKLY

Certain tempting instruments we advertised in an earlier issue had ready sales, but the list has been supplemented as under-noted:

Two-Step Amplifier, guaranteed to increase signal strength 60 times, Price, without bulbs, \$30.00.

Short Wave Regenerative Set, 150-600 meters, \$30.00

Audion Control Panel, \$11.75.

Amplifying Transformers, \$6.50.

You cannot beat the Double A Quality Goods. All our instruments are guaranteed.

We advise operators to place their orders early, to insure prompt delivery; and avoid increasing costs. These prices are effective until January 1, 1920.

### RADIO EQUIPMENT COMPANY

1525 North Fawn Street, Philadelphia

# MURDOCK

NO. 55



2000 OHM DOUBLE SET

**\$4.50**

3000 OHM DOUBLE SET

**\$5.50**

**M**ade for long and  
**U**seful service in  
**R**adio stations where their  
**D**ependable and sensitive  
**O**peration makes them the  
**C**hoice of those who  
**K**now GOOD 'phones.

**ORDER YOUR SET NOW—**  
Try it out thoroughly.  
**IF IT DOESN'T SUIT, SEND  
IT BACK AND GET YOUR  
MONEY**

Bulletin 19 shows a splendid line of the type of apparatus you want. Send for a copy.

## WM. J. MURDOCK CO.

65 Carter St.

CHELSEA MASS.

221 SECOND ST., SAN FRANCISCO, CALIF.

Picture below shows typical 15-panel DeFOREST Unit Receiving Set consisting of a Tuner with wave length range of 150 to 25,000 meters; a crystal and an audion detector, and a one-step amplifier. This set is the most complete and efficient receiving apparatus ever put out under \$150.00. Its cost is considerably less than that, the entire set of Units show here totaling only \$133.57.

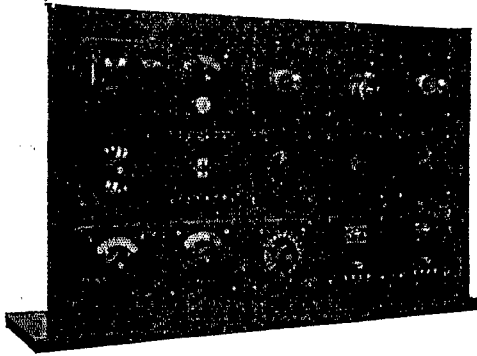

# DE FOREST Unit Receiving Set

*Gives You Better Apparatus at Low Cost*

The DE FOREST Unit Receiving set offers the only practical system of securing accurately designed, highly efficient receiving apparatus without paying for expensive factory assembly and costly cabinets. You buy the individual units and assemble them yourself, thus becoming more expert.

You can start with a few, inexpensive Units which will give you a Receiving Set of an efficient but simple type, and then build up, always fitting new Units into the system as additions to the old. No junking of old apparatus; just add to them to increase your selectivity and circuit efficiency as new developments come out.

If you are thinking of taking up wireless work, find out about the DE FOREST Unit Receiving Set before you get your apparatus. It will give you the most highly developed Radio Instruments obtainable. And if you are an Amateur, Student or Experimenter, this Unit Set holds even greater possibilities for you because in using your own ingenuity in assembling the Units you will greatly broaden your Radio knowledge.

**Send for Catalogue Q Containing Full Details**

A 64-page book of Radio Apparatus which illustrates and describes many other interesting features. Sent post-paid for 10 cents. Genuine DE FOREST Radio Apparatus is sold by Dealers in Electrical Supplies in all large cities. Ask your Dealer to show you DE FOREST Apparatus and look for the name plate.

**DE FOREST RADIO TELEPHONE & TELEGRAPH COMPANY**

*Inventors and Manufacturers of Amateur  
—and Commercial Radio Apparatus—*

**1415 SEDGWICK AVENUE,**

**NEW YORK CITY**

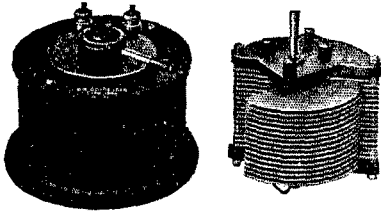

## Variable Air Condenser TYPE 182

A high grade condenser with plates designed to give approximately even variation of wavelength throughout the scale.

Made in two sizes: .0007 M. F. at \$10.00 and .001 M.F. at \$13.00.

Full data on request.

**General Radio Co.**  
WINDSOR STREET  
CAMBRIDGE MASS.

"ASK ANYONE WHO HAS USED IT"

"My Brandes Headset Never Gives Me A Headache." (Name on Request)

The fitting and lightness are very important. The Brandes Headset excels in these respects. Special attention has been given to this feature.

## BRANDES WIRELESS HEADSET



'Superior' 2000 ohms \$7

**TRIAL OFFER** Test out Brandes Wireless Receivers against any other make. Test them for sensitiveness, clearness and distance. If within ten days you're not only satisfied but enthusiastic over them—back comes your money without a question.

Prove for yourself the fine quality, the "matched tone." The two diaphragms, toned exactly alike, strengthen the signals and prevent blurring. Used by many U. S. Gov't experts, and experts abroad; by colleges and technical schools; and by professionals and amateurs everywhere.

SEND 4c. FOR CATALOGUE F

**C. BRANDES, Inc.**

Room 821, 32 Union Square, New York  
WIRELESS RECEIVER SPECIALISTS

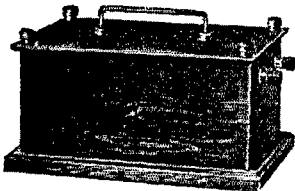

## NEW HI-VOLT STORAGE BATTERY

A new development in vacuum tube reception has been made in this New Hi-Volt Storage Battery. The feature is a self-contained battery and rectifier. The battery has a voltage of 24 and under normal use holds its charge for three weeks. When discharged all you do is to connect a 110 volts A.C. line and in three hours the battery is fully charged and ready for use.

**Economical---Efficient---Lasting**

Combined Battery and Charging Rectifier  
as Illustrated, \$15.00

Send 6c. for our catalog No. 1  
and description of Hi-Volt Storage Battery.

**The C. D. Tuska Company**  
HARTFORD, CONNECTICUT

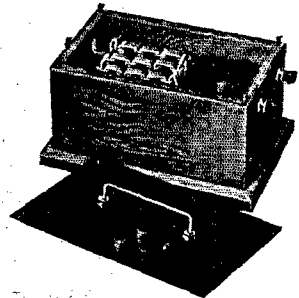

# THE BIG 15 CENTS' WORTH

**EVERYDAY ENGINEERING** spares no expense to obtain the best radio articles—for you—real information by which you can construct your own equipment—data that is dependable because every instrument is first built in **EVERYDAY'S** own radio laboratory—detailed descriptions of the newest commercial apparatus—articles making clear the principles and theory on which radio devices work—ideas for the beginners as well as for radio engineers.

**EVERYDAY ENGINEERING** spends \$500 a month for radio articles which cost you only 15 cents. Can you get such a value at as low a price any where else? Think of that and you will understand why you cannot afford to lose a single issue. A year's subscription costs \$1.50.

2 W. 45th ST. **EVERYDAY ENGINEERING** NEW YORK

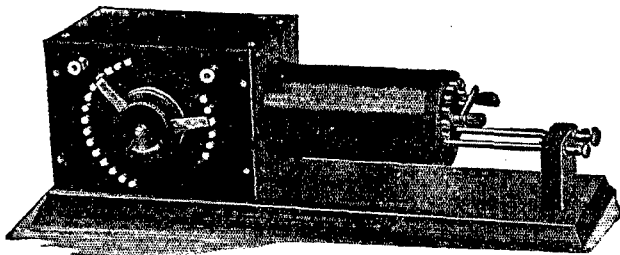

## ARNOLD NAVY MODEL LOOSE COUPLER

Altho this instrument has been before the public for five years, the demand for it is just as persistent; and altho many pre-war standards have been swept away you will find, after much experimentation with new-fangled ideas, that for selectivity and sharpness of tuning you "have to go some" to beat a well-designed Loose Coupler.

The instrument illustrated above is correctly designed, its workmanship the best, and it presents much better value than you expect—if you could see one and operate it, you would expect it to cost more.

For special design binding posts, knobs, switches, rheostats, and in fact better grade accessories, send two-cent stamp for my bulletin.

**J. F. ARNOLD**

(Established 1910)

2082 LEXINGTON AVENUE

NEW YORK

New Catalog  
of  
**Radio  
Apparatus**

**RADIO APPARATUS**  
Our apparatus  
must please you—  
all your money  
returned if it  
does not.

**Mailed Postpaid  
on Request**

**Quality  
Apparatus  
Low Prices**



**Navy Type Key  
Marble Base \$4.25  
Silver Contacts**

Ask for Catalog No. 6246Q.

**Sears, Roebuck and Co., Chicago**





# RADIO EXPERTS

*The Amateur or the Professional can depend upon our advice.*

*It means "short cuts" and the best of results with your apparatus.*

*This service is absolutely free.*

*Everything in Radio Apparatus from the "Tower to the Key."*

**A. P. Merchant Co.**

9 AVERY STREET

BOSTON

## You Fellows Outfitting Your Long Distance Stations —

Do you know that Baldwin Mica Diaphragm Telephones are many times as sensitive to weak signals as the ordinary 2000-ohm 'phones with iron diaphragms?

And that if you want to get the utmost range from your station you absolutely cannot get along without Baldwins?

Ask any long distance relay man!

The ordinary telephones fail to meet the exacting requirements of long distance radio reception in many ways; Baldwins have been designed to fill this need. In the ordinary form of receiver, the armature or diaphragm is at all times under strain due to the constant pull by the permanent magnet. In our type the armature is under no magnetic strain whatever, until a current flows through the windings—a feature unique in telephone construction. By the employment of a mica diaphragm and a separate light iron armature of small dimensions, the sensitivity is increased enormously—a most important factor in the efficient reception of weak signals.

Four models—types C, D, E, and F—four prices. Write for our interesting literature, and arrange to get your orders in now, for prices will advance January 1st on account of higher costs of material and manufacturing.

SOLE DISTRIBUTORS

**JOHN FIRTH & CO.**

81 NEW STREET

NEW YORK

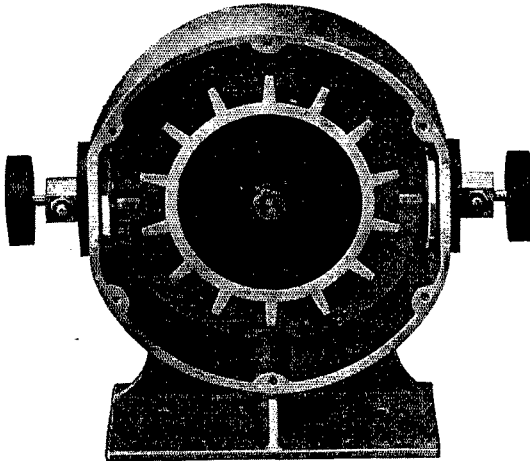

Benwood Gap—open

**AT LAST!**

A real  
**Rotary Quenched  
Spark Gap---**

**Silent in operation**

Cannot be heard outside of  
the room it is operated in.

*The "BENWOOD"*  
**Rotary Quenched Spark Gap**  
**\$27.50** (Until Jan. 1st.)

Absolutely airtight; does not heat under continuous use; **increases radiation**; gives a peculiar, clear soft note. Your transmitting set can now be operated anywhere in the house, with none of the old familiar crash and bang.

*A thing of beauty and a marvel of efficiency*

Specially designed for use with 1 k.w. transformers. Works equally well with any make on the market, regardless of voltage or power. Is furnished complete as shown with any size pulley you may designate, enabling the use of any motor to run it; and due to the fact that it is designed to be belt driven, there is no danger of burned out motors from kick back.

**Specifications:**

The disc housing is a highly polished, solid aluminum casting.

Electrodes are heavy bus bar copper with large knobs enabling the adjustment of electrodes while gap is in operation.

Disc is one piece cast aluminum.  $\frac{3}{4}$ -inch thick and six inches in diameter. Has fourteen teeth or sparking points. The logical number. The copper electrodes in conjunction with the aluminum disc gives a beautiful quenching effect that all experienced operators are familiar with.

Shaft, of disc is best tool steel turning in a bronze bearing 3 inches in length.

OVER ALL DIMENSIONS 10" x 11" x 5"

Shipped the day you order is received. Sent C. O. D. when one-third the price accompanies the order.

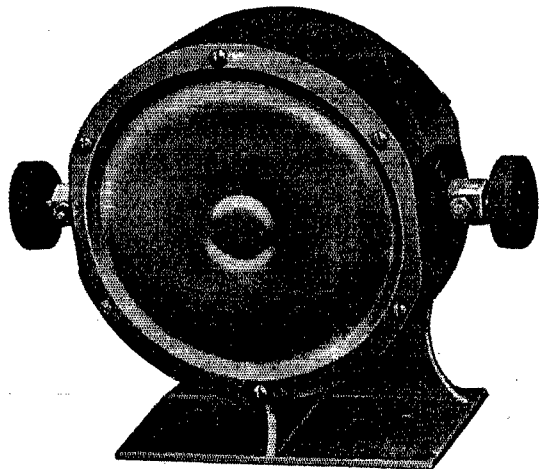

Benwood Gap—closed

**BENWOOD SPECIALTY CO., 3424 Olive St., St. Louis, Mo.**

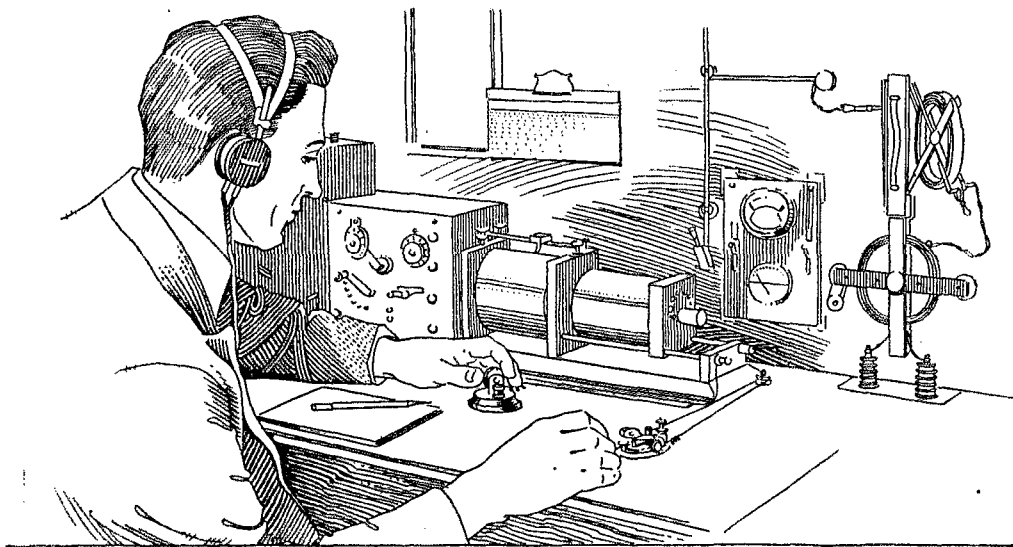

*Thousands  
in successful use ~*

If the experience of others is anything to go by, you want a Crystaloi Detector.

Our files are full of the most enthusiastic endorsements from thousands of users.

The ease with which it enables you to get the best quality in a signal—its simplicity of operation and the fact that it is inexpensive to operate make it the ideal Crystal Detector for the amateur and professional alike.

**PRICES**

Type O. Crystaloi Detector	\$3.50
By parcel post prepaid	3.60
Type A.A. Crystaloi Detector	6.00
By parcel post prepaid	6.20

BOOKLET ON REQUEST

**CONNECTICUT TELEPHONE & ELECTRIC COMPANY, Inc.**  
**MERIDEN, CONNECTICUT**

All rights and patents under which the Crystaloi is made were purchased from the inventor, Eugene T. Turney

**Crystaloi**  
*Detector*

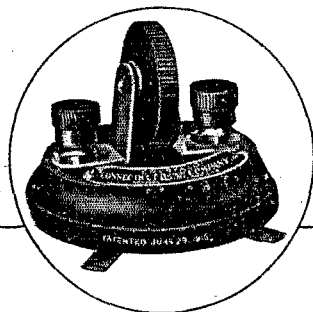

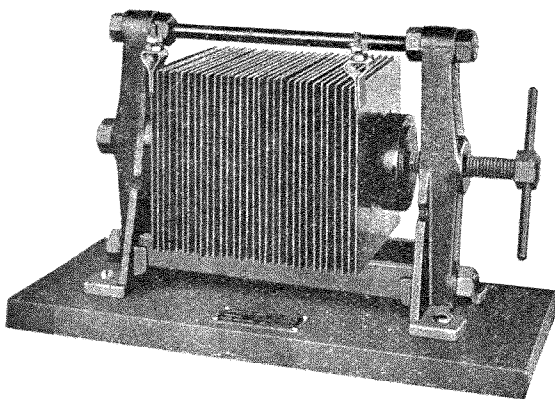

AMRAD  
Quenched Gap  
\$17.50

**Four times the energy in your antenna  
with 60 cycles and a low decrement besides**

Removal of the government ban has brought with it more severe regulations than before on transmission. For every amateur who has a sending set, the

# “AMRAD”

## QUENCHED GAP

*is practically a necessity*

This Quenched Gap does not necessitate the use of a 500 cycle generator. Properly operated on a 60 cycle circuit, it will give a 240 spark note, with less than 0.2 decrement.

Full directions for obtaining the 240 spark note, together with pamphlet giving detailed specifications, will be sent gladly on request. Ask for bulletin No. 12



AMRAD  
Detector Stand, \$4.50

Duplex stand, with selecting switch and two binding posts.

Single Stand \$2.50



AMRAD  
Lightning Switch, \$11.50

100 amperes, 500 volt single pole, double throw, mounted on three 40,000 volt Electro-se insulators

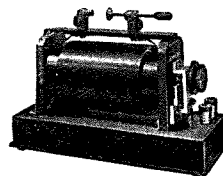

AMRAD  
Induction Coil, \$28.50

Coil for use where A. C. is not available.

**AMERICAN RADIO AND RESEARCH CORPORATION**

21 PARK ROW (Laboratory and works at Medford Hillside, Mass.)

NEW YORK